

**A reliable synthesis of discrete-time \mathcal{H}_∞ control.
Part I: basic theorems and J -lossless conjugators**

by

Piotr Jacek Suchomski

Control Systems Department, Gdańsk University of Technology
ul. Narutowicza 11/12, 80-952 Gdańsk Wrzeszcz, Poland

Abstract: The paper gives a basis for solving many problems of numerically reliable synthesis of sub-optimal discrete-time control in \mathcal{H}_∞ . The approach is based on J -lossless factorisations of the delta-domain chain-scattering descriptions of continuous-time plants being controlled. Relevant properties of poles and zeros of chain-scattering models are given. Necessary and sufficient conditions for the existence of stabilising J -lossless conjugators are presented and discussed. Some aspects of numerical conditioning of synthesis of such conjugators are considered. A numerical example illustrating synthesis of stabilising right J -lossless conjugators is also included.

Keywords: linear systems, discrete-time systems, Riccati equations, \mathcal{H}_∞ methods, lossless systems, perturbation analysis, numerical methods.

1. Introduction

It is known that a unified and systematic frequency-domain approach to control design in \mathcal{H}_∞ can be established on the three main key notions called chain-scattering representation, J -lossless factorisation and J -lossless conjugation (Kimura, 1989, 1995, 1997; Green, 1992; Tsai and Postlethwaite, 1991). In this modern methodology, the \mathcal{H}_∞ control problem can be effectively reduced to certain J -lossless factorisations of chain-scattering representations of the controlled plant, making it possible to facilitate the cascade structure of generic feedback control systems. The chain-scattering framework was introduced in the control literature by Kimura and the relevant J -lossless factorisations were recognised as an alternative expression of the well known factorisations referred to as J -spectral factorisations (Green, 1992; Zhou et al., 1996). Finally, properly defined J -lossless conjugations turned out to be a powerful tool for carrying out the J -lossless factorisations.

In this paper, which is intended as a first part of the work concerning conditioning of fundamental discrete-time \mathcal{H}_∞ -optimisation problems related to

robust control design, we consider numerical conditioning of the problem of synthesis of the so-called stabilising J -lossless conjugators for systems described by their properly defined chain-scattering models. It is a commonly accepted opinion that sensitivity analysis of the optimal and sub-optimal \mathcal{H}_∞ problems is still an open problem, although some advancing contributions have been made in recent years (Christov et al., 2005; Gahinet and Laub, 1997; Higham et al., 2004; Konstantinov et al., 1995; Lin et al., 2000). The part of the sensitivity analysis that is most complete can be found in Konstantinov et al. (1995) where conditioning of the generic 'two-Riccati' approach to the \mathcal{H}_∞ -optimisation was studied. In our approach to the sensitivity analysis of the \mathcal{H}_∞ synthesis, we will employ a different way for the linear real-rational plant modelling in the so-called δ -domain, based on a convenient chain-scattering methodology. Problems associated with the J -lossless factorisations will be discussed in a forthcoming second part of this work.

The δ -operator methodology promoted by Middleton and Goodwin (1986, 1990) and Goodwin, Middleton and Poor (1992) has been widely accepted as an effective tool of modern control system design procedures including those based on the \mathcal{H}_∞ paradigm (Collins et al., 1997; Collins and Song, 1999; Suchomski, 2002, 2003a). It is mainly due to the fact that the δ operator offering a convenient tool for describing asymptotic properties of discrete-time models of continuous-time systems as the sampling period Δ tends to zero has several advantages as compared to the common forward shift operator q , often yielding ill-conditioned processes (Feuer and Middleton, 1995; Goodwin et al., 1992; Li and Fan, 1997; Middleton and Goodwin, 1986, 1990; Salgado, Middleton and Goodwin, 1988). It was also observed that at higher sampling rates the δ -domain algorithms are much less sensitive to arithmetic roundoff errors than their counterparts algorithms based on the q operator (Fan, 1997; Fan and Liu, 1994; Feuer and Middleton, 1995; Li and Fan, 1997; Williamson, 1991).

It is worth noting that the meaning of the δ -domain representation is basically not a straightforward bilinear transform in the frequency domain. A meaningful and advantageous property of models based on the δ -operator is that the sampling period Δ appears apparently as a factor in the relevant formulas, which makes easier an extraction of all these 'algorithmic places' that may lead to a potential numerical instability (Suchomski, 2001a, b, 2003b).

A survey presentation of different developments in the δ -domain approaches for high-speed digital signal processing, computer control, system modelling, and control-oriented identification was given in Suchomski (2001c). Some recent results concerning robust proportional-integral-derivative control using generalised Kalman-Yakubowich-Popov synthesis were reported in Hara et al. (2006).

The rest of this paper is organised as follows. In Section 2, some facts of the δ -domain models of linear dynamic systems are recalled. Section 3 gives a unified treatment of discrete-time Riccati and Lyapunov equations based on the theory of matrix pencils. In Section 4, dealing with the δ -domain chain-

scattering models of generalised plants, we consider pole-zero properties of such models. An important class of linear dynamic systems, called J -lossless systems, is discussed in Section 5. Necessary and sufficient conditions for the existence of properly defined stabilising J -lossless conjugators are derived and some aspects of numerical conditioning of synthesis of such conjugators are considered. In Section 6, we present a numerical example illustrating synthesis of a stabilising right J -lossless conjugator. Some concluding remarks are given in Section 7.

2. Delta-domain modelling

We start by listing some facts and concepts concerning modelling in the δ domain. After some basic recalls, we concentrate on system poles and zeros as well as on the so-called coprime factorisations over the \mathcal{RH}_∞ .

2.1. Elements

Let \mathbb{R} and \mathbb{C} be the real and complex field, respectively, while $\mathbb{Z}_+ = \mathbb{N} \cup \{0\}$ denotes the set of all non-negative integers. Assume that $l_2 = l_2[0, \infty) = \{y : \|y\|_2 < \infty\}$ is a Banach space defined for sequences $y = \{y_k\}_{k \in \mathbb{Z}_+} = \{y_k\}_{k=0}^\infty$, where $y_k \in \mathbb{R}^r$. Let q be the forward-shift linear operator $q : l_2 \rightarrow l_2$, established as $qy_k = y_{k+1}$, $\forall y \in l_2$. The *delta operator* $\delta : l_2 \rightarrow l_2$ is defined as the following first-order divided difference $\delta = (q - 1)/\Delta$, where $\Delta > 0 \in \mathbb{R}$ is the sampling period (Middleton and Goodwin, 1986, 1990). Thus, the operators q and δ are affinely connected via the relation $q = \Delta \cdot \delta + 1$. Let (q, z) and (δ, ζ) denote the pairs of discrete-time operators q and δ , and the corresponding complex variables z and ζ , where $z = e^{s\Delta}$ and $\zeta = (e^{s\Delta} - 1)/\Delta$, while $s \in \mathbb{C}$.

Let $\mathcal{D}_\Delta = \{\zeta : |\zeta + 1/\Delta| < 1/\Delta\}$ be the open Δ -scaled shifted circle with the boundary $\partial\mathcal{D}_\Delta$. The corresponding closed circle is denoted as $\bar{\mathcal{D}}_\Delta$. The homographic mapping (*conjugation, para-Hermitian conjugation*) $\mathbb{C} \ni \zeta \mapsto \zeta^\sim = -\zeta/(1 + \Delta\zeta) \in \mathbb{C}$ transforms a complex number into its reflection with regard to the $\partial\mathcal{D}_\Delta$.

Let a linear time-invariant (*LTI*) continuous-time ($\rho = d/dt$) system be described by the following state-space model

$$\begin{cases} \rho x(t) = A_\rho x(t) + B_\rho u(t) \\ y(t) = C_\rho x(t) + D_\rho u(t) \end{cases} \quad (1)$$

where $x(t)$ is the state vector, $u(t)$ is the input, $y(t)$ denotes the output, while $\rho = d/dt$. If $u(t)$ is piece-wise constant and right-continuous (which means that a common discretisation mechanism with the first order hold is used) the following discrete-time (δ -domain) state-space model can be obtained (Goodwin et al., 1992; Middleton and Goodwin, 1986, 1990; Rao and Sinha, 1991; Rostgaard et al., 1993):

$$\begin{cases} \delta x(t) = A_\delta x(t) + B_\delta u(t) \\ y(t) = C_\delta x(t) + D_\delta u(t) \end{cases} \quad (2)$$

where now we have: $x(t) = x(k\Delta)$, $u(t) = u(k\Delta)$, $y(t) = y(k\Delta)$, and

$$A_\delta = \Delta^{-1}\Gamma_\Delta A_\rho, \quad B_\delta = \Delta^{-1}\Gamma_\Delta B_\rho, \quad C_\delta = C_\rho, \quad D_\delta = D_\rho \quad (3)$$

while $\Gamma_\Delta = \int_0^\Delta e^{\tau A_\rho} d\tau$. The integral involved in the definition of Γ_Δ can be effectively computed by using methods given in Cheng and Yau (1997), Johnson and Phillips (1971), Moler and Van Loan (1978), Ward (1977). The standard q -domain model of the continuous-time system (1) has the realisation (A_q, B_q, C_q, D_q) with

$$A_q = I + \Delta A_\delta, \quad B_q = \Delta B_\delta, \quad C_q = C_\delta, \quad D_q = D_\delta \quad (4)$$

where I acts as the properly dimensioned identity matrix.

The set of all eigenvalues of a square matrix $A \in \mathbb{R}^{n \times n}$ is denoted by $\lambda(A)$. A matrix A is said to be *stable* if $\lambda(A) \subset \mathcal{D}_\Delta$. Moreover, A is said to be *regular* while $-\Delta^{-1} \notin \lambda(A)$.

REMARK 1 If $\Delta \rightarrow 0$, then $(A_\delta \rightarrow A_\rho, B_\delta \rightarrow B_\rho)$, while the corresponding q -domain model loses its identity: $(A_q \rightarrow I, B_q \rightarrow 0)$, where 0 denotes the properly dimensioned zero matrix (Goodwin, Middleton and Poor, 1992; Middleton and Goodwin, 1990; Neuman, 1993a,b; Ninness and Goodwin, 1991; Premaratne et al., 1994). Clearly, a deep dependence of Δ is hidden in Γ_Δ and, as a matter of fact, we should write $A_q(\Delta) = I + \Delta A_\delta(\Delta)$ and $B_q(\Delta) = \Delta B_\delta(\Delta)$. Many aspects of different consequences imposed by a high sampling rate are discussed in Åström et al. (1984), Feuer and Middleton (1995), Gessing (1993, 2002), Goodwin et al. (1992), Li and Fan (1997), Middleton and Goodwin (1990), Wahlberg (1988, 1990).

2.2. Systems

Let $\mathcal{R}_p^{p \times r}$ be the space of all proper real-rational $p \times r$ matrix-valued functions in $\zeta \in \mathbb{C}$ and $\mathcal{RL}_\infty^{p \times r} \subset \mathcal{R}_p^{p \times r}$ denote the sub-space of all proper real-rational $p \times r$ matrix-valued functions that are analytical on $\partial\mathcal{D}_\Delta$. $\mathcal{RH}_\infty^{p \times r} \subset \mathcal{RL}_\infty^{p \times r}$ consists of all stable functions (i.e. functions that are analytical in $\mathbb{C} \setminus \mathcal{D}$). The set of all functions that are unitary bounded in $\mathcal{RH}_\infty^{p \times r}$ is described as $\mathcal{BH}_\infty^{p \times r} = \{G \in \mathcal{RH}_\infty^{p \times r} : \|G\|_\infty < 1\}$, where $\|\cdot\|_\infty$ is the $\mathcal{RH}_\infty^{p \times r}$ infinity norm defined as

$$\|G\|_\infty = \sup_{\omega \in [0, 2\pi/\Delta)} \left\| G \left(\frac{e^{j\omega\Delta} - 1}{\Delta} \right) \right\|_2. \quad (5)$$

The set (a group) of all units of $\mathcal{RH}_\infty^{p \times p}$, denoted as \mathcal{GH}_∞^p , is defined as $\mathcal{GH}_\infty^p = \{G \in \mathcal{RH}_\infty^{p \times p} : G^{-1} \in \mathcal{RH}_\infty^{p \times p}\}$. A function $G \in \mathcal{GH}_\infty^p$ is called *unimodular* (Feintuch, 1998). Symbols $\|G\|_\infty$, $\|G(\delta)\|_\infty$ and $\|G(\zeta)\|_\infty$ are equivalent. Note that the non-compact set $[0, 2\pi/\Delta)$ appears in (5).

Given a $G(\zeta) \in \mathcal{R}_P^{p \times r}$, we have the transfer function (transfer matrix) being a map $G : \mathcal{U} \rightarrow \mathcal{Y}$ from a space \mathcal{U} of input signals to a space \mathcal{Y} of output signals. Taking $\zeta = (e^{j\omega\Delta} - 1)/\Delta$ with $\omega \in [0, 2\pi/\Delta)$ we obtain the frequency response $G(j\omega)$ corresponding to (6). The (para-Hermitian) conjugate of $G(\zeta)$ is defined as $G^\sim(\zeta) = G^T(-\zeta/(1 + \Delta\zeta))$. The Hermitian conjugate is $G^*(\zeta) = G^T(\zeta^*)$. Hence, for $\zeta \in \partial\mathcal{D}_\Delta$ we have $G^*(\zeta) = G^\sim(\zeta)$.

Let (A, B, C, D) denote properly dimensioned matrices and

$$G(\zeta) = C(\zeta I - A)^{-1}B + D = \left[\begin{array}{c|c} A & B \\ \hline C & D \end{array} \right] \quad (6)$$

be the associated transfer matrix $G(\zeta)$. Each (A, B, C, D) leading to the given function $G(\zeta) \in \mathcal{R}_P^{p \times r}$ is called its *realisation*. The eigenvalues of A are called the *poles* of the realisation of $G(\zeta)$. Let $A \in \mathbb{R}^{n \times n}$ be regular. It implies that $I_n + \Delta A$ is non-singular and

$$G^\sim(\zeta) = \left[\begin{array}{c|c} -I_n A^T & -I_n C^T \\ \hline B^T I_n & D^T - \Delta B^T I_n C^T \end{array} \right] \quad (7)$$

where $I_n \in \mathbb{R}^{n \times n}$ is the identity matrix and $I_A = (I_n + \Delta A^T)^{-1}$. For $\lambda \in \lambda(A)$ we have $(e^{\lambda\Delta} - 1)/\Delta \in \lambda(A_\delta)$. Moreover, $A^\sim = -I_n A^T \in \mathbb{R}^{n \times n}$.

Let $\mathbb{R}[s]$ be the polynomial ring with real coefficients. A square matrix with entries in $\mathbb{R}[s]$ is called a *unimodular* polynomial matrix if its determinant is a non-zero constant. Any $G(\zeta) \in \mathcal{R}_P^{p \times r}$ can be reduced to its canonical *McMillan form* $M_G(\zeta)$ through some pre- and post-unimodular operations (Fuhrmann, 1996). Therefore, there exist properly dimensioned unimodular matrices $U_G(\zeta)$ and $V_G(\zeta)$ such that

$$U_G(\zeta)G(\zeta)V_G(\zeta) = M_G(\zeta) = \left[\begin{array}{cccccc} \frac{\alpha_1(\zeta)}{\beta_1(\zeta)} & 0 & \cdots & 0 & 0 \\ 0 & \frac{\alpha_2(\zeta)}{\beta_2(\zeta)} & \cdots & 0 & 0 \\ \vdots & \vdots & \ddots & \vdots & \vdots \\ 0 & 0 & \cdots & \frac{\alpha_{r_G}(\zeta)}{\beta_{r_G}(\zeta)} & 0 & 0 \\ 0 & 0 & \cdots & \cdots & 0 & 0 \end{array} \right] \quad (8)$$

and $\alpha_i(\zeta)$ divides $\alpha_{i+1}(\zeta)$ and $\beta_{i+1}(\zeta)$ divides $\beta_i(\zeta)$, respectively. The number $\sum_{i=1}^{r_G} \deg(\beta_i(\zeta))$ is called the *McMillan degree* of $G(\zeta)$ and is equal to the dimension of a minimal realisation of $G(\zeta)$. The roots of all the polynomials $\beta_i(\zeta)$ in the McMillan form for $G(\zeta)$ are called the *poles* of $G(\zeta)$ and are denoted as $p(G(\zeta))$. A complex number ζ_0 is a pole of $G(\zeta)$ if and only if $\zeta_0 \in \lambda(A)$ where A comes from a minimal realisation (A, B, C, D) of $G(\zeta)$. The roots of all the polynomials $\alpha_i(\zeta)$ in the McMillan form for $G(\zeta)$ are called the *transmission zeros* of $G(\zeta)$ and are denoted as $z(G(\zeta))$. A transfer matrix $G(\zeta)$ is *stable* if $p(G(\zeta)) \subset \mathcal{D}_\Delta$. Let us introduce the useful notation

$M_G(\zeta) = N_G(\zeta) \cdot D_G^{-1}(\zeta)$, where $N_G(\zeta) = \text{diag}\{\alpha_i(\zeta)\}_{i=1}^{r_G} \oplus 0_{(p-r_G) \times (r-r_G)}$ and $D_G(\zeta) = \text{diag}\{\beta_i(\zeta)\}_{i=1}^{r_G} \oplus I_{r-r_G}$ are polynomial matrices. Note that $D_G(\zeta)$ has full normal rank.

Following some standard algebras established for real-rational functions (Fuhrmann, 1996; Zhou et al., 1996) we can derive a useful lemma.

LEMMA 1 (on system poles and zeros)

(i) Assume a $G(\zeta) = G_1(\zeta) \cdot G_2(\zeta)$. Then

$$p(G(\zeta)) \subset \{p(G_1(\zeta)), p(G_2(\zeta))\}. \quad (9)$$

If $G_1(\zeta)$ has full column normal rank or $G_2(\zeta)$ has full row normal rank, then

$$z(G(\zeta)) \subset \{z(G_1(\zeta)), z(G_2(\zeta))\}. \quad (10)$$

(ii) Assume a $G(\zeta) \in \mathcal{R}_P^{(m+q) \times (r+p)}$ suitably partitioned as

$$G(\zeta) = \begin{bmatrix} G_{11}(\zeta) & G_{12}(\zeta) \\ G_{21}(\zeta) & G_{22}(\zeta) \end{bmatrix}. \quad (11)$$

Then

$$p(G_{11}(\zeta)), p(G_{12}(\zeta)), p(G_{21}(\zeta)), p(G_{22}(\zeta)) \subset p(G(\zeta)) \quad (12)$$

$$p(G(\zeta)) \subset \{p(G_{11}(\zeta)), p(G_{12}(\zeta)), p(G_{21}(\zeta)), p(G_{22}(\zeta))\}. \quad (13)$$

Let $G(\zeta)$ of (11) be a block upper triangular matrix with $G_{21}(\zeta) = 0_{q \times r}$. If $G_{11}(\zeta)$ has full row normal rank, then

$$z(G_{22}(\zeta)) \subset z(G(\zeta)). \quad (14)$$

If $G_{22}(\zeta)$ has full column normal rank, then

$$z(G_{11}(\zeta)) \subset z(G(\zeta)). \quad (15)$$

Moreover, for a quadratic block upper triangular $G(\zeta)$ with $G_{11}(\zeta) = I_m$ and $G_{22}(\zeta) = I_q$ it holds that

$$p(G(\zeta)) = z(G(\zeta)) = p(G_{12}(\zeta)). \quad (16)$$

Let $U, W \in \mathbb{R}^{m \times m}$. The set of all $m \times m$ matrices of the form $U - \zeta W$ with $\zeta \in \mathbb{C}$ is said to be a *matrix pencil*. The eigenvalues of this pencil are elements of the set $\lambda(U, W)$ defined by $\lambda(U, W) = \{\zeta \in \mathbb{C} : \det(U - \zeta W) = 0\}$. If $\lambda \in \lambda(U, W)$ and $Ux = \lambda Wx$ with $x \neq 0$ then x is referred to as an eigenvector of the pencil $U - \zeta W$ associated with the eigenvalue λ . A pencil $U - \zeta W$ is said to be *non-singular* if matrix $U - \zeta W$ is non-singular for almost all $\zeta \in \mathbb{C}$.

Non-singular pencil $U - \zeta W$ is of full normal rank, $\text{normrank}(U - \zeta W) = m$. We say that $\infty \in \lambda(U, W)$ if $\text{rank}(W) < \text{normrank}(U - \zeta W)$. Similarly, we say that a transfer matrix $G(\zeta)$ has normal rank $\text{normrank}(G(\zeta)) = n_r$ if $G(\zeta)$ has maximally possible rank n_r for at least one $\zeta \in \mathbb{C}$. Let

$$S_G(\zeta) = \begin{bmatrix} A - \zeta I_n & B \\ C & D \end{bmatrix} \quad (17)$$

denote the system matrix associated with the realisation (A, B, C, D) of a given transfer matrix $G(\zeta)$. The normal rank of this generally non-quadratic pencil, denoted as $\text{normrank}(S_G(\zeta))$, is the maximally possible rank of $S_G(\zeta)$ for at least one $\zeta \in \mathbb{C}$. A $\zeta_0 \in \mathbb{C}$ is called an *invariant zero* of this realisation if it satisfies $\text{rank}(S_G(\zeta_0)) < \text{normrank}(S_G(\zeta))$. The set of all invariant zeros of (A, B, C, D) is denoted as $z(A, B, C, D)$. It is clear that $G(\zeta)$ has full column (row) normal rank if and only if $S_G(\zeta)$ has full column (row) normal rank and $\text{normrank}(S_G(\zeta)) = n + \text{normrank}(G(\zeta))$. A $\zeta_0 \in \mathbb{C}$ is a transmission zero of a transfer matrix $G(\zeta)$ if and only if it is an invariant zero of any minimal realisation of $G(\zeta)$. Moreover, every transmission zero of a transfer matrix $G(\zeta)$ is an invariant zero of all its realisations, and every pole of a $G(\zeta)$ is a pole of all its realisations.

For matrix-valued functions in δ we need two definitions being extensions of some standard formulations (Dullerud and Paganini, 2000; Feintuch, 1998; Francis, 1987; Kailath, 1980; Vidyasagar, 1985; Zhou et al., 1996).

DEFINITION 1 (of coprimeness over \mathcal{RH}_∞)

- (i) Two matrices M and N in \mathcal{RH}_∞ are right coprime over \mathcal{RH}_∞ if they have the same number of columns and if $\begin{bmatrix} M \\ N \end{bmatrix}$ is left-invertible in \mathcal{RH}_∞ , i.e. if there exist X_r and Y_r in \mathcal{RH}_∞ such that $X_r M + Y_r N = I$.
- (ii) Two matrices \tilde{M} and \tilde{N} in \mathcal{RH}_∞ are left coprime over \mathcal{RH}_∞ if they have the same number of rows and if $[\tilde{M} \ \tilde{N}]$ is right-invertible in \mathcal{RH}_∞ , i.e. if there exist X_l and Y_l in \mathcal{RH}_∞ such that $\tilde{M} X_l + \tilde{N} Y_l = I$.

These two equations are often called *Bezout identities*. A pair of matrices that are coprime over \mathcal{RH}_∞ is also called *coprime over \mathcal{RH}_∞* .

DEFINITION 2 (of coprime factorisation over \mathcal{RH}_∞) Let $G \in \mathcal{R}_P$.

- (i) A right coprime factorisation of G is a factorisation $G = NM^{-1}$ where (M, N) is right coprime over \mathcal{RH}_∞ .
- (ii) A left coprime factorisation of G is a factorisation $G = \tilde{M}^{-1}\tilde{N}$ where (\tilde{M}, \tilde{N}) is left coprime over \mathcal{RH}_∞ .

Implicit in these definitions is the requirement that both M and \tilde{M} are square and non-singular.

3. Discrete-time Riccati and Lyapunov equations

Algebraic Riccati equations and Lyapunov equations appear in different fields of linear systems and control theory, and play a fundamental role in many modern algorithms for control synthesis including approaches based on the \mathcal{H}_∞ paradigm (Datta, 2004; Ionescu et al., 1999; Lancaster and Rodman, 1995). In this section, some properties of the δ -domain Riccati and Lyapunov equations are considered.

3.1. Riccati equations in the delta-domain

Consider the discrete-time algebraic Riccati equation (*DARE*)

$$\begin{aligned} & P_q^T X_q P_q - X_q \\ & - (P_q^T X_q Q_q + S_q)(T_q + Q_q^T X_q Q_q)^{-1}(Q_q^T X_q P_q + S_q^T) + R_q = 0_{n \times n} \end{aligned} \quad (18)$$

where $X_q, P_q, R_q = R_q^T \in \mathbb{R}^{n \times n}$, $Q_q, S_q \in \mathbb{R}^{n \times m}$, and $T_q = T_q^T \in \mathbb{R}^{m \times m}$. Taking $P_q = I_n + \Delta P$, where $P \in \mathbb{R}^{n \times n}$, two sets of matrices (Q_q, R_q, S_q, T_q) can be examined

$$\begin{aligned} (R1) \quad & (\Delta \cdot Q, R, S, T) \\ (R2) \quad & (Q, \Delta^2 \cdot R, \Delta \cdot S, T) \end{aligned} \quad (19)$$

where $R = R^T \in \mathbb{R}^{n \times n}$, $Q, S \in \mathbb{R}^{n \times m}$ and $T = T^T \in \mathbb{R}^{m \times m}$ (Suchomski, 2003a, b, 2004). In both cases we obtain the following δ -domain discrete-time algebraic Riccati equation (*δ ARE*)

$$\begin{aligned} & P^T X + X P + \Delta P^T X P - ((I_n + \Delta P^T) X Q + S) \\ & \times (T + \Delta Q^T X Q)^{-1}(Q^T X (I_n + \Delta P) + S^T) + R = 0_{n \times n} \end{aligned} \quad (20)$$

where $X \in \mathbb{R}^{n \times n}$ and

$$\begin{aligned} (R1) \quad & X = \Delta \cdot X_q \\ (R2) \quad & X = \Delta^{-1} \cdot X_q. \end{aligned} \quad (21)$$

Note that, in fact, we have $X = X(\Delta)$ and $X_q = X_q(\Delta)$. The distinguished types of parameterisation (*R1* and *R2*) follow from a simple observation that they are directly connected with all generic 'two-Riccati' formulations of the standard \mathcal{H}_∞ problem for discrete-time linear systems (Iglesias and Glower, 1991; Ionescu and Weiss, 1993; Kongprawechnon and Kimura, 1998).

Let (U, W) denote a pair of real matrices associated with the *δ ARE* of (20) (Suchomski, 2003a, b, 2004)

$$(U, W) = \left(\left[\begin{array}{ccc} P & 0_{n \times n} & Q \\ -R & -P^T & -S \\ S^T & Q^T & T \end{array} \right], \left[\begin{array}{ccc} I_n & 0_{n \times n} & 0_{n \times m} \\ 0_{n \times n} & I_n + \Delta P^T & 0_{n \times m} \\ 0_{m \times n} & -\Delta Q^T & 0_{m \times m} \end{array} \right] \right). \quad (22)$$

The set of all $(2n + m) \times (2n + m)$ matrices of the form $U - \zeta W$ with $\zeta \in \mathbb{C}$ is said to be an *extended matrix pencil*. A non-singular pencil $U - \zeta W$ is of full normal rank, $\text{normrank}(U - \lambda W) = 2n + m$. A non-singular pencil $U - \lambda W$ with a regular P is said to be a *regular pencil* while $-\Delta^{-1} \notin \lambda(U, W)$.

In many applications, the matrix T of (22) is often diagonal or even the identity, which makes T^{-1} trivial to determine and in such cases a reduced in-order generalised eigenvalue problem based on standard techniques for $2n \times 2n$ matrix pencils can be utilised (Arnold and Laub, 1984; Benner et al., 1997; Datta, 2004; Ionescu et al., 1997, 1999; Lancaster and Rodman, 1995; Saberi et al., 1995; Suchomski, 2003b). In general, T may instead be non-diagonal and ill-conditioned with respect to inversion, or possibly even singular, in which case the considered technique for $(2n + m) \times (2n + m)$ extended pencils should be used (Arnold and Laub, 1984; Datta, 2004; Ionescu et al., 1997, 1999; Ionescu and Weiss, 1992, 1993; Stoorvogel and Saberi, 1998; Suchomski, 2003b, 2004).

Consider the *DARE*

$$P_q^T X_q P_q - X_q - P_q^T X_q R_q (I_n + X_q R_q)^{-1} X_q P_q + Q_q = 0_{n \times n} \quad (23)$$

where $X_q, P_q, R_q = R_q^T, Q_q = Q_q^T \in \mathbb{R}^{n \times n}$. Taking $P_q = I_n + \Delta P$, where $P \in \mathbb{R}^{n \times n}$, two sets of matrices (Q_q, R_q) can be examined

$$\begin{aligned} (R1) \quad & (Q, \Delta^2 \cdot R) \\ (R2) \quad & (\Delta^2 \cdot Q, R) \end{aligned} \quad (24)$$

where $Q = Q^T, R = R^T \in \mathbb{R}^{n \times n}$ (Suchomski, 2003d, 2001e). In both cases we obtain the following δARE

$$\begin{aligned} & P^T X + X P + \Delta P^T X P \\ & - (I_n + \Delta P^T) X R (I_n + \Delta X R)^{-1} X (I_n + \Delta P) + Q = 0_{n \times n} \end{aligned} \quad (25)$$

where $X \in \mathbb{R}^{n \times n}$ satisfies the suitable scaling relation (21).

Let (U, W) denote a pair of real matrices associated with the δARE of (25) (Suchomski, 2002, 2003d, e)

$$(U, W) = \left(\left[\begin{array}{cc} P & -R \\ -Q & -P^T \end{array} \right], \left[\begin{array}{cc} I_n & \Delta R \\ 0_{n \times n} & I_n + \Delta P^T \end{array} \right] \right). \quad (26)$$

A non-singular pencil $U - \zeta W$ is regular if and only if P is regular.

For a triple (P, Q, R) with a regular P the following $(n + n) \times (n + n)$ -partitioned matrix $M_\Delta = M_\Delta(U, W) \in \mathbb{R}^{2n \times 2n}$ can be defined

$$M_\Delta = W^{-1} U = \left[\begin{array}{cc} P + \Delta R I_P Q & -R I_P \\ -I_P Q & -I_P P^T \end{array} \right]. \quad (27)$$

This regular matrix satisfying $I_{-nn}^{-1} M_\Delta^T I_{-nn} = -(I_n + \Delta M_\Delta)^{-1} M_\Delta$, where

$$I_{-mn} = \left[\begin{array}{cc} 0_{m \times n} & -I_m \\ I_n & 0_{n \times m} \end{array} \right] \in \mathbb{R}^{(m+n) \times (n+m)} \quad (28)$$

will be called a *generalised Hamiltonian* matrix (Suchomski, 2003e, 2004). Since $I_{-nn}^{-1}(I_n + \Delta M_\Delta^T)I_{-nn} = (I_n + \Delta M_\Delta)^{-1}$ then $I_n + \Delta M_\Delta$ is a *symplectic* (J_n -orthogonal) matrix (Bunse-Gerstner et al., 1992). Moreover, if $\lambda \in \lambda(M_\Delta)$ then λ^* , λ^\sim as well as $(\lambda^\sim)^*$ are also the eigenvalues of M_Δ .

REMARK 2 A generalised Hamiltonian matrix can also be introduced as a regular matrix $\tilde{M} \in \mathbb{R}^{2n \times 2n}$ satisfying $I_{-nn}^{-1}\tilde{M}^T I_{-nn} = -(I_n + \Delta\tilde{M})^{-1}\tilde{M}$. Given a generalised Hamiltonian matrix \tilde{M} of the $(n+n) \times (n+n)$ partitioning with a regular lower right-corner submatrix, we conclude that \tilde{M} can be represented as

$$\tilde{M} = \frac{1}{\Delta} \cdot \begin{bmatrix} \tilde{P} + \tilde{R}\tilde{P}^{-T}\tilde{Q} - I_n & -\tilde{R}\tilde{P}^{-T} \\ -\tilde{P}^{-T}\tilde{Q} & \tilde{P}^{-T} - I_n \end{bmatrix} \quad (29)$$

where $\tilde{P} \in \mathbb{R}^{n \times n}$ is a non-singular matrix and $\tilde{Q} = \tilde{Q}^T$, $\tilde{R} = \tilde{R}^T \in \mathbb{R}^{n \times n}$. Taking $\tilde{P} = I_n + \Delta P$, where $P \in \mathbb{R}^{n \times n}$ is a suitable regular matrix we obtain

$$\tilde{M} = \begin{bmatrix} P + \Delta R I_P Q & -\Delta R I_P \\ -\Delta^{-1} I_P Q & -I_P P^T \end{bmatrix} \quad (30)$$

where $\tilde{Q} = Q$, $\tilde{R} = \Delta^2 R \in \mathbb{R}^{n \times n}$. Assuming that $X \in \mathbb{R}^{n \times n}$ and $\tilde{X} \in \mathbb{R}^{n \times n}$ satisfy the following equations

$$\begin{bmatrix} -\tilde{X} & I_n \end{bmatrix} \tilde{M} \begin{bmatrix} I_n & \tilde{X} \end{bmatrix}^T = 0_{n \times n} \quad (31)$$

$$\begin{bmatrix} -X & I_n \end{bmatrix} M_\Delta \begin{bmatrix} I_n & X \end{bmatrix}^T = 0_{n \times n} \quad (32)$$

yields $X = \Delta\tilde{X}$ (Suchomski, 2003e, 2004).

LEMMA 2 (on similarity of generalised Hamiltonian matrices, Suchomski, 2004) *Let $M_{\Delta 0} \in \mathbb{R}^{2n \times 2n}$ be a generalised Hamiltonian matrix. Taking $M_\Delta = T M_{\Delta 0} T^{-1}$ with a symplectic $T \in \mathbb{R}^{2n \times 2n}$ we obtain a generalised Hamiltonian matrix $M_\Delta \in \mathbb{R}^{2n \times 2n}$.*

3.2. Basic properties of solutions of Riccati equations

Consider a pair (U, W) of (22). Let $\mathcal{X}_-(U, W)$ of dimension $n_- = \dim(\mathcal{X}_-(U, W)) \leq n$ denote an invariant subspace corresponding to stable eigenvalues of the given extended matrix pencil $U - \zeta W$. Let $[X_1^T \ X_2^T \ X_3^T]^T \in \mathbb{R}^{(n+n+m) \times n_-}$ be a matrix of a full column rank whose columns form a basis for $\mathcal{X}_-(U, W)$. This means that $\mathcal{X}_-(U, W) = \text{Im} [X_1^T \ X_2^T \ X_3^T]^T$ and

$$U \begin{bmatrix} X_1 \\ X_2 \\ X_3 \end{bmatrix} = W \begin{bmatrix} X_1 \\ X_2 \\ X_3 \end{bmatrix} \Lambda \quad (33)$$

where $\Lambda \in \mathbb{R}^{n_- \times n_-}$ is stable, $\lambda(\Lambda) \subset \mathcal{D}_\Delta$. Let $\text{dom}(\delta Ric) \subset \mathbb{R}^{(2n+m) \times (2n+m)} \times \mathbb{R}^{(2n+m) \times (2n+m)}$ denote a set of all those pairs (U, W) for which $n_- = n$ and

$X_1 \in \mathbb{R}^{n \times n}$ is non-singular. It follows that $X = X_2 X_1^{-1} \in \mathbb{R}^{n \times n}$ is uniquely determined by $(U, W) \in \text{dom}(\delta Ric)$, i.e. we have a mapping

$$\delta Ric : \text{dom}(\delta Ric) \rightarrow \mathbb{R}^{n \times n}. \quad (34)$$

Consider a pair (U, W) of (26). Let $\mathcal{X}_-(U, W)$ of dimension $n_- = \dim(\mathcal{X}_-(U, W)) \leq n$ be a stable invariant subspace of the pencil $U - \zeta W$. Assume that columns of $\bar{X} = [X_1^T \ X_2^T]^T \in \mathbb{R}^{(n+n) \times n_-}$ form a basis of this subspace. Hence, $\mathcal{X}_-(U, W) = \text{Im} \bar{X}$ and $U \bar{X} = W \bar{X} \Lambda$, where $\Lambda \in \mathbb{R}^{n_- \times n_-}$ is a stable matrix, $\lambda(\Lambda) \subset \mathcal{D}_\Delta$. If $n_- = n$ and $X_1 \in \mathbb{R}^{n \times n}$ is non-singular we can set $\delta Ric(U, W) = X_2 X_1^{-1}$ obtaining a mapping (34), where now $\text{dom}(\delta Ric) \subset \mathbb{R}^{2n \times 2n} \times \mathbb{R}^{2n \times 2n}$. $(U, W) \in \text{dom}(\delta Ric)$ only if $U - \lambda W$ has no eigenvalues on the $\partial \mathcal{D}_\Delta$.

Let $\mathcal{X}_-(M_\Delta)$ denote a stable invariant subspace of M_Δ . We have $\dim(\mathcal{X}_-(M_\Delta)) = n$ if and only if M_Δ has no eigenvalues on the $\partial \mathcal{D}_\Delta$. Then, consider an n -dimensional subspace $\mathcal{X}_-(M_\Delta)$ and its basis established by columns of a matrix $\bar{X} \in \mathbb{R}^{(n+n) \times n}$ partitioned as $\bar{X} = [X_1^T \ X_2^T]^T$. Specifically, in this case, $\text{dom}(\delta Ric) \subset \mathbb{R}^{2n \times 2n}$ consists of all generalised Hamiltonian matrices M_Δ for which the corresponding submatrices $X_1 \in \mathbb{R}^{n \times n}$ are non-singular. Now, taking $\delta Ric(M_\Delta) = X_2 X_1^{-1}$ we establish a suitable mapping (34). In this way, having an $M_\Delta = M_\Delta(U, W) \in \text{dom}(\delta Ric)$ we can also say that $(U, W) \in \text{dom}(\delta Ric)$.

The following lemma is a δ -domain restatement of the standard result (Arnold and Laub, 1984; Datta, 2004; Lancaster and Rodman, 1995; Laub, 1991; Van Dooren, 1981) that recasts the δARE of (20) as a generalised eigenvalue problem (Suchomski, 2003b, c, 2004).

LEMMA 3 (on δ -domain Riccati equations)

(I) Consider a pair (U, W) of (22) associated with an appropriate $(2n + m) \times (2n + m)$ extended matrix pencil. Let $(U, W) \in \text{dom}(\delta Ric)$ and $X = X_2 X_1^{-1} \in \mathbb{R}^{n \times n}$. Then:

- (i) $X = \delta Ric(U, W)$ is unique and symmetric, $X = X^T$;
- (ii) $T + \Delta Q^T X Q$ is non-singular and X satisfies the δARE of (20);
- (iii) $G_\delta = X_1 \Lambda X_1^{-1} = P + Q F_\delta$ is stable, $\lambda(G_\delta) \subset \mathcal{D}_\Delta$, where

$$F_\delta = X_3 X_1^{-1} = -(T + \Delta Q^T X Q)^{-1} ((I_n + \Delta P^T) X Q + S)^T. \quad (35)$$

(II) Consider a pair (U, W) of (26) associated with an appropriate $2n \times 2n$ matrix pencil. Let $(U, W) \in \text{dom}(\delta Ric)$ and $X = X_2 X_1^{-1} \in \mathbb{R}^{n \times n}$. Then:

- (i) $X = \delta Ric(U, W)$ is unique and symmetric, $X = X^T$;

(ii) $I_n + \Delta XR$ is non-singular and X satisfies the δARE of (25) and its two equivalent forms

$$\begin{aligned} & (P^T - XR)(I_n + \Delta XR)^{-1}X \\ & + (I_n + \Delta P^T)(I_n + \Delta XR)^{-1} + XP + Q = 0_{n \times n} \end{aligned} \quad (36)$$

$$(I_n + \Delta P^T)(I_n + \Delta XR)^{-1}X(P - RX) + P^T X + Q = 0_{n \times n}; \quad (37)$$

(iii) $G_\delta = P + RF_\delta = (I_n + \Delta RX)^{-1}(P - RX)$ is stable, $\lambda(G_\delta) \subset \mathcal{D}_\Delta$, where

$$F_\delta = -(I_n + \Delta XR)^{-1}X(I_n + \Delta P). \quad (38)$$

(III) Consider a generalised Hamiltonian matrix $M_\Delta(U, W)$ of (27). Let $M_\Delta \in \text{dom}(\delta Ric)$ and $X = X_2 X_1^{-1} \in \mathbb{R}^{n \times n}$. Then:

(i) $X = \delta Ric(U, W)$ is unique and symmetric, $X = X^T$;

(ii) $I_n + \Delta XR$ is non-singular and X satisfies the δARE of (25) and its two equivalent forms

$$XP + (I_n + \Delta XR)I_P Q - (XR - P^T)I_P X = 0_{n \times n} \quad (39)$$

$$(I_n + \Delta XR)I_P(X - \Delta Q) - X(I_n + \Delta P) = 0_{n \times n}; \quad (40)$$

(iii) $G_\delta = P - RI_P(X - \Delta Q)$ is stable, $\lambda(G_\delta) \subset \mathcal{D}_\Delta$.

REMARK 3 Let $M_\Delta(U, W) \in \text{dom}(\delta Ric)$ and $X = \delta Ric(M_\Delta)$. Matrices M_Δ and

$$\begin{bmatrix} P - RI_P(X - \Delta Q) & -RI_P \\ 0_{n \times n} & (XR - P^T)I_P \end{bmatrix} \quad (41)$$

are similar, hence $\lambda(M_\Delta) = \lambda(P - RI_P(X - \Delta Q)) \cup \lambda((XR - P^T)I_P)$. Since $\lambda(P - RI_P(X - \Delta Q)) \subset \mathcal{D}_\Delta$, we have $\lambda((XR - P^T)I_P) \subset \mathbb{C} \setminus \bar{\mathcal{D}}_\Delta$. It follows that M_Δ does not have eigenvalues on the $\partial \mathcal{D}_\Delta$. Moreover, $M_\Delta \in \text{dom}(\delta Ric)$ only if (P, R) is stabilisable.

Consider a generalised Hamiltonian matrix M_Δ with $Q = 0_{n \times n}$. Now, $M_\Delta \in \text{dom}(\delta Ric)$ only if P has no eigenvalues on $\partial \mathcal{D}_\Delta$. Let $x \in \mathbb{R}^n$ denote an eigenvector associated with a $\lambda \in \lambda(P)$. Taking $X = \delta Ric(M_\Delta)$ yields $(\lambda I_n - (XR - P^T)I_P)Xx = 0_n$. Moreover, for $\lambda \in \mathcal{D}_\Delta$ the instability of $(XR - P^T)I_P$ implies $x \in \text{Ker } X$. It follows that $\text{Ker } X$ is a stable invariant subspace of P , and the rank of X is equal to the number of those eigenvalues of P which belong to $\mathbb{C} \setminus \bar{\mathcal{D}}_\Delta$.

LEMMA 4 (on translation and congruence of solutions of δ -domain Riccati equations, Suchomski, 2004) *Let $M_{\Delta_0} \in \mathbb{R}^{2n \times 2n}$ be a generalised Hamiltonian matrix, $M_{\Delta_0} \in \text{dom}(\delta Ric)$ and $X_0 = \delta Ric(M_{\Delta_0})$. Matrix $M_\Delta = TM_{\Delta_0}T^{-1} \in \mathbb{R}^{2n \times 2n}$ with the following non-singular $T \in \mathbb{R}^{2n \times 2n}$*

$$a) \quad T = \begin{bmatrix} I_n & 0_{n \times n} \\ T_0 & I_n \end{bmatrix}, \quad T_0 = T_0^T \in \mathbb{R}^{n \times n} \quad (42)$$

$$b) \quad T = \begin{bmatrix} T_0^{-1} & 0_{n \times n} \\ 0_{n \times n} & T_0^T \end{bmatrix}, \quad T_0 \in \mathbb{R}^{n \times n}, \quad \det(T_0) \neq 0 \quad (43)$$

is a generalised Hamiltonian matrix, $M_\Delta \in \text{dom}(\delta Ric)$, and $X = \delta Ric(M_\Delta)$. There is

$$a) \quad X = X_0 + T_0 \quad (44)$$

$$b) \quad X = T_0^T X_0 T_0. \quad (45)$$

Any Schur-like numerical method based on estimating the bases of stable invariant subspaces and deflating subspaces can be utilised for solving the considered $\delta AREs$ (Arnold and Laub, 1984; Bunse-Gerstner et al., 1992; Kenney et al., 1989; Laub, 1979, 1991; Pappas et al., 1980; Petkov et al., 1987; Van Dooren, 1981). The recently derived inverse-free generalized Schur method should be recommended for its numerical stability properties (Datta, 2004; Van Dooren, 1981, 2004). Abundant collections of suitable benchmark numerical examples prepared for testing different methods for solving Riccati equations are given in Abels and Benner (1999), Benner et al. (1995), Benner et al. (1997), Petkov et al. (1998).

3.3. Lyapunov equations in the delta-domain

Consider the discrete-time Lyapunov (Stein) equation

$$P_q^T X_q P_q - X_q + Q_q = 0_{n \times n} \quad (46)$$

where $X_q = X_q(\Delta)$, $P_q, Q_q = Q_q^T \in \mathbb{R}^{n \times n}$. Taking $P_q = I_n + \Delta P$, where $P \in \mathbb{R}^{n \times n}$, two sets of matrices Q_q can be examined

$$\begin{aligned} (L1) \quad & Q \\ (L2) \quad & \Delta^2 \cdot Q \end{aligned} \quad (47)$$

where $Q = Q^T \in \mathbb{R}^{n \times n}$. In both cases we obtain the following δ -domain discrete-time Lyapunov equation

$$P^T X + X P + \Delta P^T X P + Q = 0_{n \times n} \quad (48)$$

where $X = X(\Delta) \in \mathbb{R}^{n \times n}$ and

$$\begin{aligned} (L1) \quad & X = \Delta \cdot X_q \\ (L2) \quad & X = \Delta^{-1} \cdot X_q. \end{aligned} \quad (49)$$

The equation (48) has a unique solution if and only if $\lambda_i(P) + \lambda_j(P) + \Delta\lambda_i(P)\lambda_j(P) \neq 0, \forall i, j$. A numerically robust method for solving the δ -domain Lyapunov equations was presented in Suchomski (2001a).

Suppose that P is stable. $X \geq 0$ if $Q \geq 0$. If $Q \geq 0$, then (P, Q) is observable if and only if $X > 0$. On the other hand, suppose that X is the solution of the Lyapunov equation (48), then $\lambda(P) \subset \mathcal{D}_\Delta$ if $X > 0$ and $Q \geq 0$. Moreover, P is stable if $X \geq 0, Q \geq 0$ and (P, Q) is detectable.

3.4. Numerical conditioning of discrete-time Riccati and Lyapunov equations

Many questions concerning numerical conditioning of the considered discrete-time Riccati and Lyapunov equations were discussed in Suchomski (2001a, b, 2003b) where some useful sensitivity characteristics of these equations were evaluated by using suitably defined condition numbers. It was demonstrated that for many standard (non-singular) problems in the \mathcal{H}_∞ , having the assumed types of parameterisation, most of the δ -domain formulations are much better conditioned than their conventional shift operator counterparts as the sampling period is sufficiently small.

Let $(U, W) \in \text{dom}(\delta Ric)$ and P, Q, R, S and T be subject to additive perturbations $\varepsilon\bar{P}, \varepsilon\bar{Q}, \varepsilon\bar{R}, \varepsilon\bar{S}$ and $\varepsilon\bar{T}$, respectively. It is assumed that \bar{R} and \bar{T} are both symmetric, and $\varepsilon \in \mathbb{R}$. Note that when (20) is solved on a computer having machine precision $\hat{\varepsilon}$, rounding errors of order $\hat{\varepsilon}\|P\|_F, \hat{\varepsilon}\|Q\|_F, \hat{\varepsilon}\|R\|_F, \hat{\varepsilon}\|S\|_F$, and $\hat{\varepsilon}\|T\|_F$ will be present in the corresponding matrices, where $\|\cdot\|_F$ denotes the Frobenius matrix norm (Higham, 1996; Konstantinov et al., 2003). Let $\nabla_\varepsilon X(\bar{P}, \bar{Q}, \bar{R}, \bar{S}, \bar{T} | P, Q, R, S, T)$ and $\nabla X(P, Q, R, S, T)$ denote the directional derivative and the corresponding Fréchet derivative of $X = \delta Ric(U, W)$, respectively. The following norm of $\nabla X(P, Q, R, S, T)$ serves as a useful measure of a local sensitivity of X with respect to small perturbations in data matrices (Suchomski, 2001b, 2003b)

$$\|\nabla X(P, Q, R, S, T)\| = \tag{50}$$

$$\sup_{\|(\bar{P}, \bar{Q}, \bar{R}, \bar{S}, \bar{T})\| \neq 0} \frac{\|\nabla_\varepsilon X(\|P\|_F \bar{P}, \|Q\|_F \bar{Q}, \|R\|_F \bar{R}, \|S\|_F \bar{S}, \|T\|_F \bar{T} | P, Q, R, S, T)\|_F}{\|(\bar{P}, \bar{Q}, \bar{R}, \bar{S}, \bar{T})\|_F}$$

A perturbed solution has the form $\tilde{X} = X + \varepsilon \nabla_\varepsilon X(\|P\|_F \bar{P}, \|Q\|_F \bar{Q}, \|R\|_F \bar{R}, \|S\|_F \bar{S}, \|T\|_F \bar{T} | P, Q, R, S, T)$. Based on the above, the following relative condition number of the δ ARE of (20) can be defined

$$\kappa(P, Q, R, S, T) = \frac{\|\nabla X(P, Q, R, S, T)\|}{\|X\|_F}, \quad \|X\|_F \neq 0. \tag{51}$$

A relative condition number of the q -domain ARE of (18), denoted as $\kappa_q(P_q, Q_q, R_q, S_q, T_q)$, is defined in a similar manner and the following lemma can be derived by using a first-order-in- Δ analysis.

LEMMA 5 (on conditioning of discrete-time Riccati equations, Suchomski, 2001b, 2003b) *For a sufficiently small sampling period Δ there is*

$$\kappa_q(P_q, Q_q, R_q, S_q, T_q) \propto \frac{1}{\Delta} \cdot \kappa(P, Q, R, S, T). \quad (52)$$

REMARK 4 If some knowledge about structural properties of the perturbations affecting (P, Q, R, S, T) is available it can be employed by using an injective linear mapping $e \rightarrow \text{vec}(\bar{P}, \bar{Q}, \bar{R}, \bar{S}, \bar{T})$ characterised by properly defined 'pattern' matrices $(E_P, E_Q, E_R, E_S, E_T)$ describing linearised models of the particular perturbations, where e denotes an appropriate dimensioned vector of unstructured perturbations (Suchomski, 2003b). Clearly, if the structure of perturbations is taken into account, it may essentially change the estimates for relative condition numbers.

CONCLUSION 1 For non-singular problems the δ -domain approach based on the Riccati equation machinery is much better conditioned than the corresponding q -domain approach as $\Delta \rightarrow 0$. For some singular problems both the δ - and the q -operator methods exhibit an undesirable high sensitivity, but the δ -domain approach is no worse than the q -domain approach, in the sense that κ_q and κ are of the same order (Suchomski, 2003b).

4. Chain-scattering models and their properties

Staying in the δ -domain we can consider a so-called *generalised plant* described by its *scattering matrix*

$$P : \begin{bmatrix} \mathcal{W} \\ \mathcal{U} \end{bmatrix} \rightarrow \begin{bmatrix} \mathcal{Z} \\ \mathcal{Y} \end{bmatrix}, \quad P(\zeta) = \begin{bmatrix} P_{zw}(\zeta) & P_{zu}(\zeta) \\ P_{yw}(\zeta) & P_{yu}(\zeta) \end{bmatrix} \quad (53)$$

with four input/output signals (Fig. 1): $w \in \mathcal{W}$ is the exogenous input of dimension r , $u \in \mathcal{U}$ of dimension p denotes the controlling input, $z \in \mathcal{Z}$ of dimension m is the controlled output (objective) and $y \in \mathcal{Y}$ acts as the measured output of dimension q (see Kimura, 1995, 1997, and Zhou et al., 1996).

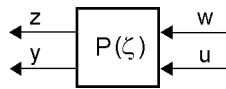

Figure 1. Generalised plant described by scattering matrix.

For a $P \in \mathcal{R}_P^{(m+q) \times (r+p)}$ we can assume that its realisation (A, B, C, D) , where A, B, C and D are properly dimensioned real matrices with $A \in \mathbb{R}^{n \times n}$, is represented as

$$P(\zeta) = \left[\begin{array}{c|c} A & B \\ \hline C & D \end{array} \right] = \left[\begin{array}{c|cc} A & B_w & B_u \\ \hline C_z & D_{zw} & D_{zu} \\ C_y & D_{yw} & D_{yu} \end{array} \right]. \quad (54)$$

4.1. Basic facts

The main reason for using the so-called chain-scattering notations for plant modelling lies in their simplicity of representing cascade connections (Deville and Dym, 1981; Genin et al., 1983; Green, 1992; Green et al., 1990; Kimura, 1991, 1995, 1997; Kimura and Okunishi, 1995; Kongprawechnon and Kimura, 1996, 1998; Lee et al., 1996; Tsai and Postlethwaite, 1991; Tsai and Tsai, 1992, 1993, 1995; Tsai et al., 1993). The cascade connection of two chain-scattering models, which actually contains feedback connections of two suitable systems, is represented simply as a product of each chain-scattering matrix. This property of the chain-scattering models is widely employed in various fields of system theory and engineering to represent some scattering properties of a physical system, the relationship between the power ports, etc. (Kimura, 1997; Tsai and Tsai, 1992, 1993; Kongprawechnon and Kimura, 1998).

Any plant P of (53) with $q = r$ and an invertible $P_{yw}(\zeta)$ can be characterised via its *chain-scattering* representation

$$G : \begin{bmatrix} \mathcal{U} \\ \mathcal{Y} \end{bmatrix} \rightarrow \begin{bmatrix} \mathcal{Z} \\ \mathcal{W} \end{bmatrix}, \quad G(\zeta) = \begin{bmatrix} G_{zu}(\zeta) & G_{zy}(\zeta) \\ G_{wu}(\zeta) & G_{wy}(\zeta) \end{bmatrix} \quad (55)$$

where the appropriate chain transformation is defined as

$$G = \mathcal{F}_c(P) = \begin{bmatrix} P_{zu} - P_{zw}P_{yw}^{-1}P_{yu} & P_{zw}P_{yw}^{-1} \\ -P_{yw}^{-1}P_{yu} & P_{yw}^{-1} \end{bmatrix}. \quad (56)$$

Similarly to the above, any plant with $m = p$ and an invertible $P_{zu}(\zeta)$ can be characterised via its *dual chain-scattering* representation

$$H : \begin{bmatrix} \mathcal{Z} \\ \mathcal{W} \end{bmatrix} \rightarrow \begin{bmatrix} \mathcal{U} \\ \mathcal{Y} \end{bmatrix}, \quad H(\zeta) = \begin{bmatrix} H_{uz}(\zeta) & H_{uw}(\zeta) \\ H_{yz}(\zeta) & H_{yw}(\zeta) \end{bmatrix} \quad (57)$$

where the dual chain transformation is defined as

$$H = \mathcal{F}_{dc}(P) = \begin{bmatrix} P_{zu}^{-1} & -P_{zu}^{-1}P_{zw} \\ P_{yu}P_{zu}^{-1} & P_{yw} - P_{yu}P_{zu}^{-1}P_{zw} \end{bmatrix}. \quad (58)$$

For a real-rational $P \in \mathcal{R}_P^{(m+q) \times (r+p)}$ the above mentioned invertibility refers to $\mathcal{R}_P^{r \times r}$ and $\mathcal{R}_P^{m \times m}$, respectively.

4.2. Poles and zeros of chain-scattering models

Let G of (55) be the chain-scattering model of a certain generalised plant P . Then P is represented in terms of G

$$P = \mathcal{F}_c^{-1}(G) = \begin{bmatrix} G_{zy}G_{wy}^{-1} & G_{zu} - G_{zy}G_{wy}^{-1}G_{wu} \\ G_{wy}^{-1} & -G_{wy}^{-1}G_{wu} \end{bmatrix}. \quad (59)$$

An analogous reasoning applies to the dual case. Assuming that H of (57) is the dual chain-scattering model of a P , yields

$$P = \mathcal{F}_{dc}^{-1}(H) = \begin{bmatrix} -H_{uz}^{-1}H_{uw} & H_{uz}^{-1} \\ H_{yw} - H_{yz}H_{uz}^{-1}H_{uw} & H_{yz}H_{uz}^{-1} \end{bmatrix}. \quad (60)$$

Let (56) and (59) be rewritten as factored forms, respectively:

$$G = \begin{bmatrix} I_m & P_{zw} \\ 0_{r \times m} & I_r \end{bmatrix} \begin{bmatrix} P_{zu} & 0_{m \times r} \\ 0_{r \times p} & P_{yw}^{-1} \end{bmatrix} \begin{bmatrix} I_p & 0_{p \times r} \\ -P_{yu} & I_r \end{bmatrix} \quad (61)$$

$$P = \begin{bmatrix} I_m & G_{zy} \\ 0_{r \times m} & I_r \end{bmatrix} \begin{bmatrix} G_{zu} & 0_{m \times r} \\ 0_{r \times p} & G_{wy}^{-1} \end{bmatrix} \begin{bmatrix} 0_{p \times r} & I_p \\ I_r & -G_{wu} \end{bmatrix}. \quad (62)$$

Let (58) and (60) be rewritten as factored forms, respectively:

$$H = \begin{bmatrix} I_m & 0_{m \times q} \\ P_{yu} & I_q \end{bmatrix} \begin{bmatrix} P_{zu}^{-1} & 0_{m \times r} \\ 0_{q \times m} & P_{yw} \end{bmatrix} \begin{bmatrix} I_m & -P_{zw} \\ 0_{r \times m} & I_r \end{bmatrix} \quad (63)$$

$$P = \begin{bmatrix} 0_{m \times q} & I_m \\ I_q & H_{yz} \end{bmatrix} \begin{bmatrix} H_{yw} & 0_{q \times m} \\ 0_{m \times r} & H_{uz}^{-1} \end{bmatrix} \begin{bmatrix} I_r & 0_{r \times m} \\ -H_{uw} & I_m \end{bmatrix}. \quad (64)$$

LEMMA 6 (on poles and zeros of chain-scattering models)

(i) Assume a $G(\zeta) = \mathcal{F}_c(P)(\zeta)$. Then

$$p(G(\zeta)) \subset \{p(P_{zw}(\zeta)), p(P_{zu}(\zeta)), z(P_{yw}(\zeta)), p(P_{yu}(\zeta))\} \quad (65)$$

$$z(G(\zeta)) \subset \{p(P_{zw}(\zeta)), z(P_{zu}(\zeta)), p(P_{yw}(\zeta)), p(P_{yu}(\zeta))\} \quad (66)$$

$$z(P_{yw}(\zeta)) \subset p(G(\zeta)) \quad (67)$$

$$z(P_{zu}(\zeta)) \subset z(G(\zeta)). \quad (68)$$

(ii) Assume a $P(\zeta) = \mathcal{F}_c^{-1}(G)(\zeta)$. Then

$$p(P(\zeta)) \subset \{p(G_{zu}(\zeta)), p(G_{zy}(\zeta)), p(G_{wu}(\zeta)), z(G_{wy}(\zeta))\} \quad (69)$$

$$z(P(\zeta)) \subset \{z(G_{zu}(\zeta)), p(G_{zy}(\zeta)), p(G_{wu}(\zeta)), p(G_{wy}(\zeta))\} \quad (70)$$

$$z(G_{wy}(\zeta)) \subset p(P(\zeta)) \quad (71)$$

$$z(P_{zu}(\zeta)) \subset z(P(\zeta)). \quad (72)$$

(iii) Assume an $H(\zeta) = \mathcal{F}_{dc}(P)(\zeta)$. Then

$$p(H(\zeta)) \subset \{p(P_{zw}(\zeta)), z(P_{zu}(\zeta)), p(P_{yw}(\zeta)), p(P_{yu}(\zeta))\} \quad (73)$$

$$z(H(\zeta)) \subset \{p(P_{zw}(\zeta)), p(P_{zu}(\zeta)), z(P_{yw}(\zeta)), p(P_{yu}(\zeta))\} \quad (74)$$

$$z(P_{zu}(\zeta)) \subset p(H(\zeta)) \quad (75)$$

$$z(P_{yw}(\zeta)) \subset z(H(\zeta)). \quad (76)$$

(iv) Assume a $P(\zeta) = \mathcal{F}_{dc}^{-1}(H)(\zeta)$. Then

$$p(P(\zeta)) \subset \{z(H_{zu}(\zeta)), p(H_{uw}(\zeta)), p(H_{yz}(\zeta)), p(H_{yw}(\zeta))\} \quad (77)$$

$$z(P(\zeta)) \subset \{p(H_{uz}(\zeta)), p(H_{uw}(\zeta)), p(H_{yz}(\zeta)), z(H_{yw}(\zeta))\} \quad (78)$$

$$z(H_{uz}(\zeta)) \subset p(P(\zeta)) \quad (79)$$

$$z(H_{yw}(\zeta)) \subset z(P(\zeta)). \quad (80)$$

Proof. Let $G(\zeta) = \mathcal{F}_c(P)(\zeta)$. (65), (66) and (67) follow directly from *Lemma 1*, (56) and (61). Considering a McMillan form for $P_{zw}(\zeta)$, we have $P_{zw}(\zeta) = U_{zw}^{-1}(\zeta) \cdot N_{zw}(\zeta) \cdot D_{zw}^{-1}(\zeta) \cdot V_{zw}^{-1}(\zeta)$, where $U_{zw}(\zeta)$ and $V_{zw}(\zeta)$ are properly dimensioned unimodular polynomial matrices while $N_{zw}(\zeta)$ and $D_{zw}(\zeta)$ are suitable diagonal polynomial matrices. The first factor of (61) can thus be represented as

$$\begin{aligned} & \begin{bmatrix} I_m & P_{zw} \\ 0_{r \times m} & I_r \end{bmatrix} = \\ & = \begin{bmatrix} U_{zw}^{-1} & 0_{m \times r} \\ 0_{r \times m} & V_{zw} D_{zw} \end{bmatrix} \begin{bmatrix} I_m & N_{zw} \\ 0_{r \times m} & I_r \end{bmatrix} \begin{bmatrix} U_{zw} & 0_{m \times r} \\ 0_{r \times m} & D_{zw}^{-1} V_{zw}^{-1} \end{bmatrix}. \end{aligned} \quad (81)$$

Consequently, we obtain the following convenient equality

$$\begin{bmatrix} I_m & N_{zw} \\ 0_{r \times m} & I_r \end{bmatrix} \begin{bmatrix} U_{zw} P_{zu} & 0_{m \times r} \\ -D_{zw}^{-1} V_{zw}^{-1} P_{yu}^{-1} P_{yu} & D_{zw}^{-1} V_{zw}^{-1} P_{yw}^{-1} \end{bmatrix} = \quad (82)$$

$$= \begin{bmatrix} U_{zw} & 0_{m \times r} \\ 0_{r \times m} & D_{zw}^{-1} V_{zw}^{-1} \end{bmatrix} G \quad (83)$$

where the left factor of (82) is a unimodular polynomial matrix and the left factor of (83) is a matrix of full normal rank. *Lemma 1* now implies

$$z(P_{zu}) \subset \left\{ z \left(\begin{bmatrix} U_{zw} & 0_{m \times r} \\ 0_{r \times m} & D_{zw}^{-1} V_{zw}^{-1} \end{bmatrix} \right), z(G) \right\}. \quad (84)$$

Since U_{zw} and V_{zw}^{-1} are unimodular polynomial matrices, we have

$$z \left(\begin{bmatrix} U_{zw} & 0_{m \times r} \\ 0_{r \times m} & D_{zw}^{-1} V_{zw}^{-1} \end{bmatrix} \right) = \emptyset. \quad (85)$$

This clearly forces $z(P_{zu}(\zeta)) \subset z(G(\zeta))$ as claimed.

The proof for $P(\zeta) = \mathcal{F}_c^{-1}(G)(\zeta)$, $H(\zeta) = \mathcal{F}_{dc}(P)(\zeta)$ and $P(\zeta) = \mathcal{F}_{dc}^{-1}(H)(\zeta)$ is similar. \blacksquare

5. J -lossless systems and J -lossless conjugators

The key role in the \mathcal{H}_∞ -control is played by the so-called J -lossless factorisations of real-rational functions (Deville and Dym, 1981; Genin et al., 1983; Green,

1992; Green et al., 1990; Hung and Chu, 1998; Kimura, 1991, 1992a, 1992b, 1995, 1997; Kimura and Okunishi, 1995; Suchomski, 1995; Tsai and Postlethwaite, 1991; Tsai and Tsai, 1992, 1993, 1995; Tsai et al., 1993). J -lossless factorisations, being an alternative expression of the well known factorisation in the literature of \mathcal{H}_∞ -control, which is referred to as J -spectral factorisation (Francis, 1987; Zhou et al., 1996), allow to facilitate the cascade structure of synthesis (Kimura et al., 1991; Kimura, 1997).

5.1. J -lossless systems

Given $J_{mn} = I_m \oplus (-I_n) \in \mathbb{R}^{(m+n) \times (m+n)}$ acting as an indefinite signature matrix, let us recall some relevant definitions and lemmas concerning the losslessness properties of real-rational functions (Suchomski, 2004).

DEFINITION 3 (of losslessness)

- (i) A function $G(\zeta) \in \mathcal{RH}_\infty^{(m+r) \times (p+r)}$ is said to be lossless, if $G^\sim(\zeta) \cdot G(\zeta) = I_{p+r}, \forall \zeta$.
- (ii) A function $H(\zeta) \in \mathcal{RH}_\infty^{(m+q) \times (m+r)}$ is said to be dual lossless, if $H(\zeta) \cdot H^\sim(\zeta) = I_{m+q}, \forall \zeta$.

DEFINITION 4 (of J -unitariness and J -losslessness)

- (i) A function $G(\zeta) \in \mathcal{RL}_\infty^{(m+r) \times (p+r)}$ is said to be (J_{mr}, J_{pr}) -unitary, if $G^\sim(\zeta) \cdot J_{mr} \cdot G(\zeta) = J_{pr}, \forall \zeta$.
- (ii) A (J_{mr}, J_{pr}) -unitary function $G(\zeta)$ is said to be (J_{mr}, J_{pr}) -lossless, if $G^*(\zeta) \cdot J_{mr} \cdot G(\zeta) \leq J_{pr}, \forall \zeta \in \mathbb{C} \setminus \mathcal{D}_\Delta$.
- (iii) A function $H(\zeta) \in \mathcal{RL}_\infty^{(m+q) \times (m+r)}$ is said to be dual (J_{mq}, J_{mr}) -unitary, if $H(\zeta) \cdot J_{mr} \cdot H^\sim(\zeta) = J_{mq}, \forall \zeta$.
- (iv) A dual (J_{mq}, J_{mr}) -unitary function $H(\zeta)$ is said to be dual (J_{mq}, J_{mr}) -lossless, if $H(\zeta) \cdot J_{mr} \cdot H^*(\zeta) \geq J_{mq}, \forall \zeta \in \mathbb{C} \setminus \mathcal{D}_\Delta$.

If a $G(\zeta)$ satisfies $G^\sim(\zeta) \cdot G(\zeta) = I_{p+r}, \forall \zeta$, and the stability is not required, $G(\zeta)$ is said to be *unitary*. Analogously, an $H(\zeta)$ satisfying $H(\zeta) \cdot H^\sim(\zeta) = I_{m+q}, \forall \zeta$, is called *dual unitary*. Note that a J_{mr} -unitary matrix $D \in \mathbb{R}^{(m+r) \times (m+r)}$ is also dual J_{mr} -unitary and $D^{-1} = J_{mr} M^T J_{mr}$.

Assume that (A, B, C, D) with a regular $A \in \mathbb{R}^{n \times n}$ is a minimal realisation of a stable $G(\zeta) \in \mathcal{RH}_\infty^{(m+r) \times (p+r)}$. Let $X = X^T \in \mathbb{R}^{n \times n}$ denote the observability Gramian associated with the pair (A, C) . Hence, $X > 0$ satisfies the Lyapunov equation $A^T X + X A + \Delta A^T X A + C^T C = 0_{n \times n}$. It is seen that $G^\sim(\zeta) \cdot G(\zeta) = G_-(\zeta) + G_+(\zeta) + (D^T - \Delta B^T I_A C^T) D$, where the strictly proper component $G_-(\zeta) = (B^T I_A X + (D^T - \Delta B^T I_A C^T) C) (\zeta I_n - A)^{-1} B$ is stable, and the strictly proper component $G_+(\zeta) = -B^T I_A (\zeta I_n + I_A A^T)^{-1} (X B + I_A C^T D)$ is anti-stable. Claiming that $X B + I_A C^T D = 0_{n \times (p+r)}$, we have $B^T I_A X + (D^T - \Delta B^T I_A C^T) C = 0_{(p+r) \times n}$ and consequently $G^\sim(\zeta) \cdot G(\zeta) = D^T D + \Delta B^T X B$. Letting $D^T D + \Delta B^T X B = I_{p+r}$ and recalling the *maximum modulus theorem*

(Conway, 1978; Dullerud and Paganini, 2000; Green and Limebeer, 1995), we observe that $G^*(\zeta) \cdot G(\zeta) \leq I_{r+p}$, $\forall \zeta \in \mathbb{C} \setminus \mathcal{D}_\Delta$. On account of the above, we can state the following lemma.

LEMMA 7 (on necessary and sufficient condition for losslessness)

(i) A function $G(\zeta) \in \mathcal{RH}_\infty^{(m+r) \times (p+r)}$ of a minimal realisation (A, B, C, D) with a regular $A \in \mathbb{R}^{n \times n}$ is lossless if and only if there exists a matrix $X = X^T \in \mathbb{R}^{n \times n}$, $X > 0$, satisfying:

$$A^T X + X A + \Delta A^T X A + C^T C = 0_{n \times n} \quad (86)$$

$$X B + \Delta A^T X B + C^T D = 0_{n \times (p+r)} \quad (87)$$

$$D^T D + \Delta B^T X B = I_{p+r}. \quad (88)$$

(ii) A function $H(\zeta) \in \mathcal{RH}_\infty^{(m+q) \times (m+r)}$ of a minimal realisation (A, B, C, D) with a regular $A \in \mathbb{R}^{n \times n}$ is dual lossless if and only if there exists a matrix $Y = Y^T \in \mathbb{R}^{n \times n}$, $Y > 0$, satisfying:

$$A Y + Y A^T + \Delta A Y A^T + B B^T = 0_{n \times n} \quad (89)$$

$$Y C^T + \Delta A Y C^T + B D^T = 0_{n \times (m+q)} \quad (90)$$

$$D D^T + \Delta C Y C^T = I_{m+q}. \quad (91)$$

J -unitary and J -lossless functions may be unstable but they should have no poles on the $\partial \mathcal{D}_\Delta$. A D -matrix of any J -unitary and any J -lossless $G(\zeta) \in \mathcal{RL}_\infty^{(m+r) \times (p+r)}$ should have a full column rank, while a D -matrix of any dual J -unitary and dual J -lossless $H(\zeta) \in \mathcal{RL}_\infty^{(m+q) \times (m+r)}$ should be of a full row rank.

REMARK 5 Let a lossless function $P(\zeta)$ stand for a scattering matrix of a generalised plant described by (53). Hence, $P^\sim(\zeta) \cdot P(\zeta) = I_{r+p}$, $\forall \zeta$. Assume that there exists a chain-scattering matrix $G(\zeta) = \mathcal{F}_c(P(\zeta))$. It is seen that a suitable isometry condition takes the form of the equality $G^\sim(\zeta) \cdot J_{mr} \cdot G(\zeta) = J_{pr}$, $\forall \zeta$.

A function $G(\zeta)$ is (J_{mr}, J_{pr}) -unitary (lossless) if and only if it is a chain-scattering representation $G(\zeta) = \mathcal{F}_c(P(\zeta))$ of a unitary (lossless) function $P(\zeta)$ (a simple proof for $p = m$ can be found in Genin et al., 1983). Due to Definition 4, we have $G_{zy}^\sim(\zeta) \cdot G_{zy}(\zeta) - G_{wy}^\sim(\zeta) \cdot G_{wy}(\zeta) = -I_r$, $\forall \zeta$, which implies that $G_{wy}(\zeta)^{-1}$ exists. Hence, from (55) and (56) it follows that $P(\zeta) = \mathcal{F}_c^{-1}(G)(\zeta) = N(\zeta) \cdot D^{-1}(\zeta)$, where

$$N(\zeta) = \begin{bmatrix} G_{zu}(\zeta) & G_{zy}(\zeta) \\ 0_{r \times p} & I_r \end{bmatrix}, \quad D(\zeta) = \begin{bmatrix} G_{wu}(\zeta) & G_{wy}(\zeta) \\ I_p & 0_{p \times r} \end{bmatrix}. \quad (92)$$

For this reason $J_{pr} - G^\sim(\zeta) \cdot J_{mr} \cdot G(\zeta) = D^\sim(\zeta) \cdot D(\zeta) - N^\sim(\zeta) \cdot N(\zeta)$. It is clear that $P(\zeta)$ is unitary if and only if $D^\sim(\zeta) \cdot D(\zeta) = N^\sim(\zeta) \cdot N(\zeta)$ and $P(\zeta)$ is

lossless if and only if it is unitary and $D^*(\zeta) \cdot D(\zeta) - N^*(\zeta) \cdot N(\zeta) \geq 0, \forall \zeta \in \mathbb{C} \setminus \mathcal{D}_\Delta$. The same conclusions can be drawn for the suitable dual properties. An $H(\zeta)$ is dual (J_{mq}, J_{mr}) -unitary (lossless) if and only if $H(\zeta) = \mathcal{F}_{dc}(P)(\zeta)$, where $P(\zeta)$ is a dual unitary (lossless) function. It is worth noting that J -losslessness can be regarded as an extension of the losslessness property of linear operators acting in Hilbert spaces for a more general case of Krein spaces endowed with indefinite metrics generated by suitable signature matrices (Bognar, 1974; Hassibi et al., 1999; Kailath et al., 2000).

On account of the above we can formulate the following necessary and sufficient conditions for J -unitariness and J -losslessness of real-rational functions represented by their state-space realisations.

LEMMA 8 (on necessary and sufficient condition for J -unitariness and J -losslessness)

(I) Consider a function $G(\zeta) \in \mathcal{RL}_\infty^{(m+r) \times (p+r)}$ of a realisation (A, B, C, D) with a regular $A \in \mathbb{R}^{n \times n}$.

(i) Let (A, B, C, D) be a minimal realisation. Then $G(\zeta)$ is (J_{mr}, J_{pr}) -unitary if and only if there exists a matrix $X = X^T \in \mathbb{R}^{n \times n}$ satisfying:

$$A^T X + X A + \Delta A^T X A + C^T J_{mr} C = 0_{n \times n} \quad (93)$$

$$X B + \Delta A^T X B + C^T J_{mr} D = 0_{n \times (p+r)} \quad (94)$$

$$D^T J_{mr} D + \Delta B^T X B = J_{pr}. \quad (95)$$

(ii) Conditions (93)–(95) imply (J_{mr}, J_{pr}) -unitariness of $G(\zeta)$. Conditions (93)–(95) and $X \geq 0$ imply (J_{mr}, J_{pr}) -losslessness of $G(\zeta)$.

(II) Consider a function $H(\zeta) \in \mathcal{RL}_\infty^{(m+q) \times (m+r)}$ of a realisation (A, B, C, D) with a regular $A \in \mathbb{R}^{n \times n}$.

(i) Let (A, B, C, D) be a minimal realisation. Then $H(\zeta)$ is dual (J_{mq}, J_{mr}) -unitary if and only if there exists a matrix $Y = Y^T \in \mathbb{R}^{n \times n}$ satisfying:

$$A Y + Y A^T + \Delta A Y A^T - B J_{mr} B^T = 0_{n \times n} \quad (96)$$

$$Y C^T + \Delta A Y C^T - B J_{mr} D^T = 0_{n \times (m+q)} \quad (97)$$

$$D J_{mr} D^T - \Delta C Y C^T = J_{mq}. \quad (98)$$

(ii) Conditions (96)–(98) imply dual (J_{mq}, J_{mr}) -unitariness of $H(\zeta)$. Conditions (96)–(98) and $Y \geq 0$ imply dual (J_{mq}, J_{mr}) -losslessness of $H(\zeta)$.

It is worth noting that parts (ii) of the above lemma do not need minimality. (A, C) detectable implies $X \geq 0$ and (A, C) observable implies $X > 0$. Analogously, (A, B) reachable implies $Y \geq 0$ and (A, B) controllable implies $Y > 0$ (see also Genin et al., 1983; Tsai and Postlethwaite, 1991).

Some important properties of J -lossless functions are listed in next two lemmas with *Lemma 9* following immediately from *Lemma 8*.

LEMMA 9 (on realisations of J -lossless functions)

- (i) Any (J_{mr}, J_{pr}) -lossless function $G(\zeta) \in \mathcal{RL}_\infty^{(m+r) \times (p+r)}$ has full column normal rank and can be represented by the following observable realisation

$$G(\zeta) = \left[\begin{array}{c|c} A & -X^{-1}I_A C^T \\ \hline C & J_{mr} \end{array} \right] D, \quad A \in \mathbb{R}^{n \times n} \quad (99)$$

where $\mathbb{R}^{n \times n} \ni X > 0$ satisfies the Lyapunov equation $A^T X + X A + \Delta A^T X A + C^T J_{mr} C = 0_{n \times n}$, while $D \in \mathbb{R}^{(m+r) \times (p+r)}$ is a full column rank solution of $D^T (J_{mr} + \Delta C I_A^T X^{-1} I_A C^T) D = J_{pr}$. Having $m = p$ implies non-singularity of $D \in \mathbb{R}^{(p+r) \times (p+r)}$.

- (ii) Any dual (J_{mq}, J_{mr}) -lossless function $H(\zeta) \in \mathcal{RL}_\infty^{(m+q) \times (m+r)}$ has full row normal rank and can be represented by the following controllable realisation

$$H(\zeta) = D \left[\begin{array}{c|c} A & B \\ \hline B^T I_A Y^{-1} & J_{mr} \end{array} \right], \quad A \in \mathbb{R}^{n \times n} \quad (100)$$

where $\mathbb{R}^{n \times n} \ni Y > 0$ satisfies the Lyapunov equation $A Y + Y A^T + \Delta A Y A^T - B J_{mr} B^T = 0_{n \times n}$, while $D \in \mathbb{R}^{(m+q) \times (m+r)}$ is a full row rank solution of $D (J_{mr} - \Delta B^T I_A Y^{-1} I_A^T B) D^T = J_{mr}$. Having $r = q$ implies non-singularity of $D \in \mathbb{R}^{(m+q) \times (m+q)}$.

LEMMA 10 (on zeros and poles of J -lossless functions, Suchomski, 2003c, 2004)
If ζ_0 is a zero of a (dual) J -lossless function, then ζ_0^\sim is a pole of this function.

Considering the above requirements addressed to D -matrices of J -lossless systems we can observe an important difference between the continuous-time and the δ -domain formulations. The latter is more complicated mainly because of the fact that in this case D is not a simple constant (dual) J -unitary matrix (Kimura, 1992a, 1997) but appears as a matrix which depends on the corresponding δ -domain (dual) Lyapunov equation.

5.2. Conjugation

Let $G(\zeta) \in \mathcal{R}_P^{(m+r) \times (p+r)}$. Each function $G_r(\zeta) \in \mathcal{R}_P^{(p+r) \times (p+r)}$ such that all poles of $G(\zeta) \cdot G_r(\zeta)$ are equal to the conjugates of the corresponding poles of $G(\zeta)$ is said to be a *right conjugator* of $G(\zeta)$. Clearly, $G_r(\zeta)$ is not unique. Let (A, B, C, D) with a regular $A \in \mathbb{R}^{n \times n}$ denote a minimal realisation of $G(\zeta)$ and (A_r, B_r, C_r, D_r) with $A_r \in \mathbb{R}^{n_r \times n_r}$ be a realisation of a right conjugator of $G(\zeta)$. Taking $n_r = n$ and $A_r = A^\sim$ yields a model of $G(\zeta) \cdot G_r(\zeta)$ for which a suitable sufficient condition for the uncontrollability of all modes associated

with eigenvalues of A can easily be formulated. Thus, considering an appropriate similarity relation gives

$$P_r B_r - B D_r = 0_{n \times (p+r)} \quad (101)$$

$$(A P_r + B C_r)(I_n + \Delta A^T) + P_r A^T = 0_{n \times n} \quad (102)$$

where $G(\zeta)$ is represented by the pair (A, B) and $P_r \in \mathbb{R}^{n \times n}$ is a parameter. Each function $G_r(\zeta)$ represented by a realisation (A^\sim, B_r, C_r, D_r) such that for a given P_r equalities (101) and (102) are satisfied will be call a *right conjugator* of (A, B) with a regular A . It follows that $G(\zeta) \cdot G_r(\zeta)$ with a right conjugator $G_r(\zeta)$ can be represented as

$$G(\zeta) \cdot G_r(\zeta) = \left[\begin{array}{c|c} A^\sim & B_r \\ \hline D C_r + C P_r & D D_r \end{array} \right]. \quad (103)$$

Similar arguments apply to the case of a *left conjugator* $G_l(\zeta)$ defined for a pair (A, C) with a regular $A \in \mathbb{R}^{n \times n}$ and $C \in \mathbb{R}^{(m+q) \times n}$. $G_l(\zeta)$ is represented by a realisation (A_l, B_l, C_l, D_l) with $A_l \in \mathbb{R}^{n_l \times n_l}$. Taking $n_l = n$ and $A_l = A^\sim$ yields

$$C_l P_l + D_l C = 0_{(m+q) \times n} \quad (104)$$

$$(I_n + \Delta A^T)(P_l A - B_l C) + A^T P_l = 0_{n \times n} \quad (105)$$

with a parameter $P_l \in \mathbb{R}^{n \times n}$. Hence, $G_l(\zeta) \cdot G(\zeta)$ with a left conjugator $G_l(\zeta)$ can be represented as

$$G_l(\zeta) \cdot G(\zeta) = \left[\begin{array}{c|c} A^\sim & B_l D - P_l B \\ \hline C_l & D_l D \end{array} \right]. \quad (106)$$

The above preliminary settlements can serve as a convenient basis for more detailed definitions of conjugators satisfying some additional requirements. Namely, in the sequel, we always require that each conjugator is invertible, i.e. the non-singularity of its D_r matrix is expected.

Consider a controllable pair (A, B) . From (101) it follows that $B = P_r B_r D_r^{-1}$. Assuming $x^T P_r = 0_{1 \times n}$ to hold for a non-zero $x \neq 0_n \in \mathbb{R}^n$ we should accept that $x^T B = 0_{1 \times (p+r)}$. On the other hand, from (102) we have $(I_n + \Delta A) P_r = P_r A - \Delta B C_r$. Consequently, $x^T (I_n + \Delta A) P_r = 0_{1 \times n}$ and $x^T (I_n + \Delta A) B = 0_{1 \times (p+r)}$. Proceeding by induction on k , we obtain $x^T (I_n + \Delta A)^k B = 0_{1 \times (p+r)}$, $\forall k \geq 0$, which however contradicts the assumed controllability of (A, B) . Consequently, zeroing of x implies non-singularity of P_r . The same reasoning applies to the case of an observable pair (A, C) , where we have $P_l (I_n + \Delta A) = I_A P_l + \Delta B_l C$. This gives the following lemma:

LEMMA 11 (on conjugator parameterisations)

- (i) If (A^\sim, B_r, C_r, D_r) with a non-singular $D_r \in \mathbb{R}^{(p+r) \times (p+r)}$ is a right conjugator for a controllable pair (A, B) , then a suitable parameter matrix P_r satisfying (101) and (102) is non-singular.

(ii) If (A^\sim, B_l, C_l, D_l) with a non-singular $D_l \in \mathbb{R}^{(m+q) \times (m+q)}$ is a left conjugator for an observable pair (A, C) , then a suitable parameter matrix P_l satisfying (104) and (105) is non-singular.

Since $A^\sim - B_r D_r^{-1} C_r = P_r^{-1} A P_r$, it follows that suitable zeros of each right conjugator $G_r(\zeta)$ coincide with the corresponding poles of $G(\zeta)$. The analogous observation applies to left conjugators for which we have $A^\sim - B_l D_l^{-1} C_l = P_l A P_l^{-1}$. In general, the specified realisations (A^\sim, B_r, C_r, D_r) and (A^\sim, B_l, C_l, D_l) are thus non-minimal.

5.3. Stabilising J -lossless conjugators

A special class of conjugations plays an important role in \mathcal{H}_∞ system (control) theory, which is called a *J -lossless conjugation*, a conjugation by a J -lossless functions (Hung and Chu, 1998; Kimura 1989, 1991, 1992a, b, 1997; Kongprawechnon and Kimura, 1996; Liu and Mita, 1989). If a J -lossless conjugation is performed in such a way that only the unstable eigenvalues of the given matrix A are replaced by their conjugates we will call it a *stabilising J -lossless conjugation*. Connections between the continuous-time J -lossless conjugators and the well-known Nevanlinna-Pick rational interpolation problem were discussed in Kimura (1989, 1995, 1997) Kongprawechnon and Kimura, 1996). In this sub-section, we introduce a notion of the discrete-time δ -domain J -lossless conjugations, which gives a powerful tool for computing J -lossless factorisations.

The following theorem gives useful necessary and sufficient conditions for the existence of stabilising J -lossless conjugators. A properly defined anti-stabilising case can be treated analogously by employing anti-stable invariant subspaces of suitable matrix pencils or generalised Hamiltonian matrices.

THEOREM 1 (on necessary and sufficient conditions for the existence of stabilising J -lossless conjugators)

(i) Let (A, B) denote a controllable pair with a regular $A \in \mathbb{R}^{n \times n}$ and $B \in \mathbb{R}^{n \times (p+r)}$. A stabilising right J_{pr} -lossless conjugator associated with (A, B) exists if and only if $(U_x, W_x) \in \text{dom}(\delta Ric)$ and $X_r = \delta Ric(U_x, W_x) \geq 0$, where:

$$\begin{aligned} P_x &= A, & Q_x &= B, & R_x &= 0_{n \times n} \\ S_x &= 0_{n \times (p+r)}, & T_x &= J_{pr}. \end{aligned} \quad (107)$$

If such a solution X_r exists, then

$$G_r(\zeta) = \left[\begin{array}{c|c} \hat{A}_r & B D_r \\ \hline F_r & D_r \end{array} \right] \quad (108)$$

$$= \left[\begin{array}{c|c} A^\sim & X_r B D_r \\ \hline -J_{pr} B^T I_A & D_r \end{array} \right] \quad (109)$$

where a stable $\hat{A}_r \in \mathbb{R}^{n \times n}$ is given by

$$\hat{A}_r = A + B F_r \quad (110)$$

and

$$F_r = -J_{pr}B^T I_A X_r \quad (111)$$

$$= -D_r J_{pr} D_r^T B^T X_r (I_n + \Delta A) \quad (112)$$

$$= -J_{pr} B^T (I_n + \Delta X_r B J_{pr} B^T)^{-1} X_r (I_n + \Delta A) \quad (113)$$

while a non-singular $D_r \in \mathbb{R}^{(p+r) \times (p+r)}$ satisfies

$$D_r^T (J_{pr} + \Delta B^T X_r B) D_r = J_{pr}. \quad (114)$$

(ii) Let (A, C) denote an observable pair with a regular $A \in \mathbb{R}^{n \times n}$ and $C \in \mathbb{R}^{(m+q) \times n}$. A stabilising left dual J_{mq} -lossless conjugator associated with (A, C) exists if and only if $(U_y, W_y) \in \text{dom}(\delta Ric)$ and $Y_l = \delta Ric(U_y, W_y) \geq 0$, where:

$$\begin{aligned} P_y &= A^T, & Q_y &= C^T, & R_y &= 0_{n \times n} \\ S_y &= 0_{n \times (m+q)}, & T_y &= -J_{mq}. \end{aligned} \quad (115)$$

If such a solution Y_l exists, then

$$G_l(\zeta) = \left[\begin{array}{c|c} \hat{A}_l & H_l \\ \hline D_l C & D_l \end{array} \right] \quad (116)$$

$$= \left[\begin{array}{c|c} A^\sim & I_A C^T J_{mq} \\ \hline D_l C Y_l & D_l \end{array} \right] \quad (117)$$

where a stable $\hat{A}_l \in \mathbb{R}^{n \times n}$ is given by

$$\hat{A}_l = A + H_l C \quad (118)$$

and

$$H_l = Y_l I_A C^T J_{mq} \quad (119)$$

$$= (I_n + \Delta A) Y_l C^T D_l^T J_{mq} D_l \quad (120)$$

$$= (I_n + \Delta A) Y_l (I_n - \Delta C^T J_{mq} C Y_l)^{-1} C^T J_{mq} \quad (121)$$

while a non-singular $D_l \in \mathbb{R}^{(m+q) \times (m+q)}$ satisfies

$$D_l (J_{mq} - \Delta C Y_l C^T) D_l^T = J_{mq}. \quad (122)$$

Proof. (\Rightarrow) Let (A_r, B_r, C_r, D_r) denote a realisation of a stabilising right J_{pr} -lossless conjugator associated with a pair (A, B) , where $A_r \in \mathbb{R}^{n_+ \times n_+}$, $n_r = n_+$ and $\lambda(A_r) \subset \mathcal{D}_\Delta$, while n_+ is the number of unstable eigenvalues of A . Having assumed that we are faced with a non-trivial case of $n_+ > 0$ let us consider the following similarity relation with the suitable $(n + n_+) \times (n + n_+)$ partitioning

$$\left[\begin{array}{cc} A & BC_r \\ 0_{n_+ \times n} & A_r \end{array} \right] \left[\begin{array}{cc} M_- & M_+ \\ N_- & N_+ \end{array} \right] = \left[\begin{array}{cc} M_- & M_+ \\ N_- & N_+ \end{array} \right] \left[\begin{array}{cc} A_- & 0_{n \times n_+} \\ 0_{n_+ \times n} & A_+ \end{array} \right] \quad (123)$$

where $A_- \in \mathbb{R}^{n \times n}$, $A_+ \in \mathbb{R}^{n_+ \times n_+}$, $\lambda(A_-) \subset \mathcal{D}_\Delta$ contains all stable and all δ -conjugated unstable eigenvalues of A , while $\lambda(A_+) \subset \mathbb{C} \setminus \bar{\mathcal{D}}_\Delta$ contains all unstable eigenvalues of A . All modes of $G(\zeta) \cdot G_r(\zeta)$ associated with $\lambda(A_+)$ are uncontrollable, hence

$$\begin{bmatrix} BD_r \\ B_r \end{bmatrix} = \begin{bmatrix} M_- & M_+ \\ N_- & N_+ \end{bmatrix} \begin{bmatrix} B_- \\ 0_{n_+ \times (p+r)} \end{bmatrix} \quad (124)$$

where $B_- \in \mathbb{R}^{n \times (p+r)}$. To show that $M_- \in \mathbb{R}^{n \times n}$ is non-singular we will proceed by contradiction. Taking $x^T M_- = 0_{1 \times n}$ with a non-zero $x \in \mathbb{R}^n$ and recalling that D_r is non-singular we should accept that $x^T B = 0_{1 \times (p+r)}$. Since $AM_- + BC_r N_- = M_- A_-$, we have $x^T AM_- = 0_{1 \times n}$. Therefore $\text{Ker } M_-^T \subset \text{Ker } B^T$ and $A^T x \in \text{Ker } B^T$. A simple induction on k yields $x^T A^k B = 0_{1 \times (p+r)}$, $\forall k \geq 0$, which contradicts the assumed controllability of (A, B) . Consequently, from (123) and (124) it follows that

$$B_r = SBD_r \quad (125)$$

$$A_- = M_-^{-1}(A + BC_r S)M_- \quad (126)$$

where $S = N_- M_-^{-1} \in \mathbb{R}^{n_+ \times n}$. Moreover, $A_r S = S \hat{A}_r$, where $\mathbb{R}^{n \times n} \ni \hat{A}_r = A + BC_r S = M_- A_- M_-^{-1}$ is stable. From the assumed J_{pr} -losslessness of the conjugator, by (94) of *Lemma 8*, we obtain $C_r = -J_{pr} B^T S^T X (I_{n_+} + \Delta A_r)$, where $\mathbb{R}^{n_+ \times n_+} \ni X \geq 0$. Employing (93) of the same lemma gives the required δARE of the form

$$\begin{aligned} & A^T X_r + X_r A + \Delta A^T X_r A \\ & - (I_n + \Delta A^T) X_r B J_{pr} B^T (I_n + \Delta X_r B J_{pr} B^T)^{-1} X_r (I_n + \Delta A) = 0_{n \times n} \end{aligned} \quad (127)$$

where $\mathbb{R}^{n \times n} \ni X_r = S^T X S \geq 0$. Since

$$(I_n + \Delta X_r B J_{pr} B^T)^{-1} X_r (I_n + \Delta A) = I_A X_r \quad (128)$$

it follows that $\hat{A}_r = A + BF_r$ where $F_r = -J_{pr} B^T I_A X_r$. Finally, (95) of *Lemma 8* gives the condition (114) concerning D_r . The next *Lemma 12* shows that obtaining $X_r = \delta Ric(U_x, W_x) \geq 0$ guarantees that such a non-singular D_r always exists. A 'generic' reduced-order model of the considered stabilising right J_{pr} -lossless conjugator can thus be expressed as

$$G_r(\zeta) = \left[\begin{array}{c|c} A_r & SBD_r \\ \hline -J_{pr} B^T S^T X (I_{n_+} + \Delta A_r) & D_r \end{array} \right]. \quad (129)$$

Two non-minimal realisations of the conjugator are given below. From (128) we have $S^T X (I_{n_+} + \Delta A_r) S = I_A X_r$. Hence, $S^T X (I_{n_+} + \Delta A_r) (\zeta I_{n_+} - A_r)^{-1} S = I_A X_r (\zeta I_n - \hat{A}_r)^{-1}$. It follows that a 'practical' (i.e. stable and tractable from the implementation viewpoint - no a priori knowledge about n_+ is required)

realisation of the conjugator can be described by (108). On the other hand, when looking for the 'direct' (unstable) realisation (109) we observe that due to (127) and (128) one obtains

$$A^T X_r + X_r \hat{A}_r + \Delta A^T X_r \hat{A}_r = 0_{n \times n}. \quad (130)$$

Consequently, $X_r \hat{A}_r = A^\sim X_r$, which shows that both the distinguished representations of the conjugator are equivalent.

(\Leftarrow) Let $X_r \in \mathbb{R}^{n \times n}$ denote a stabilising solution of (127). It is a simple matter to check that $G_r(\zeta)$ of (109) satisfies all requirements for J_{pr} -losslessness given in *Lemma 8*. Therefore, it remains to prove that the order of $G_r(\zeta)$ is equal to the number of unstable eigenvalues of A . Let $\lambda \in \lambda(A)$ be a stable eigenvalue of A and $x \in \mathbb{R}^n$ denote an associated right eigenvector. From (130) it follows that $x^T X_r (\hat{A}_r - \lambda^\sim I_n) = 0_{1 \times n}$. Since \hat{A}_r is stable, $x \in \text{Ker } X_r$. Now, according to (111), we have $Ax = \hat{A}_r x$. Therefore, taking into account that $\lambda \in \lambda(\hat{A}_r)$, we conclude that x can be regarded as a right eigenvector of \hat{A}_r corresponding to λ . Hence, from (108) it follows that λ acts as an unobservable mode of the first realisation of the conjugator. On the other hand, x can be recognised as a left eigenvector of A^\sim associated with $\lambda^\sim \in \lambda(A^\sim)$. Finally, from (109) we can conclude that λ^\sim is an uncontrollable mode of the second realisation of the considered stabilising right J_{pr} -lossless conjugator. This finishes the main part of the proof. The case of a stabilising left dual J_{mq} -lossless conjugator is treated analogously. \blacksquare

The above formulation is matched to the methodology based on extended matrix pencils. Considering employing of the suitable reduced-order pencils, which is admissible since T_x and T_y are non-singular, we should use the triples $(P_x = A, Q_x = 0_{n \times n}, R_x = B J_{pr} B^T)$ or $(P_y = A^T, Q_y = 0_{n \times n}, R_y = -C^T J_{mq} C)$, respectively.

The following lemma shows that having $X_r \geq 0$ and $Y_l \geq 0$ we assure the existence of a non-singular $D_r \in \mathbb{R}^{(p+r) \times (p+r)}$ and a non-singular $D_l \in \mathbb{R}^{(m+q) \times (m+q)}$ described by *Theorem 1*.

LEMMA 12 (on sufficient conditions for the existence of block triangular non-singular D -matrices of stabilising J -lossless conjugators) *Let $X_r \geq 0$ and $Y_l \geq 0$ be as it is stated in Theorem 1. There exist block triangular and non-singular matrices $D_r \in \mathbb{R}^{(p+r) \times (p+r)}$ and $D_l \in \mathbb{R}^{(m+q) \times (m+q)}$ that satisfy (114) and (122), respectively.*

Proof. Consider, for example, the case concerning left conjugation. From (40) it follows that $Y_l = (I_n + \Delta A)(I_n - \Delta Y_l C^T J_{mq} C)^{-1} Y_l (I_n + \Delta A^T)$. Since $Y_l \geq 0$, for a regular A we have $(I_n - \Delta Y_l C^T J_{mq} C)^{-1} Y_l \geq 0$. We claim that $(I_n - \Delta Y_l C^T J_{mq} C)^{-1}$, being a symmetric matrix, is also positive definite. Conversely, suppose that $\lambda < 0$ is an eigenvalue of $(I_n - \Delta Y_l C^T J_{mq} C)^{-1}$ and $x \in \mathbb{R}^n$

denotes a corresponding left eigenvector. Hence, $x^T(I_n - \Delta Y_l C^T J_{mq} C)^{-1} Y_l x = \lambda x^T Y_l x < 0$, contrary to the previous statement. Indeed, equality $x^T Y_l x = 0$ can not be true, since otherwise $Y_l x = 0_n$ forces a contradiction with the assumption $\lambda < 0$. Therefore, $\Delta C_m^T C_m Y_l < I_n + \Delta C_q^T C_q Y_l$, where $C_m \in \mathbb{R}^{m \times n}$ and $C_q \in \mathbb{R}^{q \times n}$ are the submatrices of $C = \begin{bmatrix} C_m^T & C_q^T \end{bmatrix}^T \in \mathbb{R}^{(m+q) \times n}$. Assume that D_l has the $(m+q) \times (m+q)$ block upper triangular structure (for the block upper triangular structure we proceed analogously)

$$D_l = \begin{bmatrix} D_{l11} & D_{l12} \\ 0_{q \times m} & D_{l22} \end{bmatrix}. \quad (131)$$

$Y_l \geq 0$ implies that $\mathbb{R}^{q \times q} \ni D_{l22} > 0$ satisfying $D_{l22}(I_q + \Delta C_q Y_l C_q^T) D_{l22}^T = I_q$ always exists and can be obtained via the standard Cholesky factorisation. Next, by employing the matrix inversion lemma (Meyer, 2000) we can show that $D_{l11} \in \mathbb{R}^{m \times m}$ satisfies $D_{l11}(I_m - \Delta C_m Y_l (I_n + \Delta C_q^T C_q Y_l)^{-1} C_m^T) D_{l11}^T = I_m$. Submatrix $D_{l11} > 0$ exists, provided that $\Delta C_m Y_l (I_n + \Delta C_q^T C_q Y_l)^{-1} C_m^T < I_m$, which is, however, a direct consequence of the previous arguments. Having obtained D_{l11} , we compute $D_{l12} = -\Delta D_{l11} C_m Y_l C_q^T D_{l22}^T D_{l22}$. ■

We see at once that the corresponding continuous-time formulations for J -lossless conjugations are essentially simpler. Namely, for this case the only requirements being addressed at D_r and D_l concern their J -unitariness: D_r should be a constant J_{pr} -unitary matrix and D_l should be a constant dual J_{mq} -unitary matrix (Kimura, 1997). Since these matrices are independent of the corresponding solutions of relevant continuous-time Riccati equations, it follows immediately that suitable D_r and D_l can always be found. On the other hand, from Lemma 12 we see that the existence of $X_r \geq 0$ and $Y_l \geq 0$ assures that D_r satisfying (114) and D_l satisfying (122) can also always be obtained.

Given a particular solution $D_{r0} \in \mathbb{R}^{(p+r) \times (p+r)}$ to (114), we can define a set of relevant solutions by taking $D_r = D_{r0} \bar{J}_{pr}$, where $\bar{J}_{pr} \in \mathbb{R}^{(p+r) \times (p+r)}$ denotes a J_{pr} -unitary parameter matrix. Similarly, for (122) there is $D_l = \hat{J}_{mq} D_{l0}$, where $D_{l0} \in \mathbb{R}^{(m+q) \times (m+q)}$ is a particular solution to (122) and a (dual) J_{mq} -unitary matrix $\hat{J}_{mq} \in \mathbb{R}^{(m+q) \times (m+q)}$ stands for a parameter. Therefore we can speak of two multivalued mappings: $D_r : \mathbb{R}^{n \times n} \times \mathbb{R}^{n \times (p+r)} \rightarrow \mathbb{R}^{(p+r) \times (p+r)}$ and $D_l : \mathbb{R}^{n \times n} \times \mathbb{R}^{(m+q) \times n} \rightarrow \mathbb{R}^{(m+q) \times (m+q)}$, respectively.

REMARK 6 Considering a stabilising right J_{pr} -lossless conjugator $G_r(\zeta)$ of (108) we obtain

$$G(\zeta) \cdot G_r(\zeta) = \left[\begin{array}{c|c} \hat{A}_r & B D_r \\ \hline C + D F_r & D D_r \end{array} \right] \quad (132)$$

where all modes associated with $G(\zeta)$ are uncontrollable. We will show that each zero of the conjugated system $G(\zeta) \cdot G_r(\zeta)$ is a zero of $G(\zeta)$. Letting $\vartheta \in \mathbb{R}$ be a zero of $G(\zeta) \cdot G_r(\zeta)$, we have a vector $\begin{bmatrix} x_1^T & x_2^T \end{bmatrix}^T \neq 0_{n+(p+r)} \in \mathbb{R}^{n+(p+r)}$

such that

$$\begin{bmatrix} A + BF_r - \vartheta I_n & BD_r \\ C + DF_r & DD_r \end{bmatrix} \begin{bmatrix} x_1 \\ x_2 \end{bmatrix} = 0_{n+(m+r)}. \quad (133)$$

Hence, for $\tilde{x}_2 = D_r x_2 + F_r x_1 \in \mathbb{R}^{p+r}$ there holds

$$\begin{bmatrix} A - \vartheta I_n & B \\ C & D \end{bmatrix} \begin{bmatrix} x_1 \\ \tilde{x}_2 \end{bmatrix} = 0_{n+(m+r)}. \quad (134)$$

Since D_r is non-singular, (134) shows that ϑ is a zero of $G(\zeta)$.

Let ζ_0 be a pole of $G(\zeta)$ to be conjugated by a stabilising right J_{pr} -lossless conjugator $G_r(\zeta)$. Then, due to *Lemma 10*, $G_r(\zeta)$ must have ζ_0 as its pole.

Analogously to the above we can examine the case concerning a stabilising left dual J_{mq} -lossless conjugator of (116). This gives

$$G_l(\zeta) \cdot G(\zeta) = \left[\begin{array}{c|c} \hat{A}_l & B + H_l D \\ \hline D_l C & D_l D \end{array} \right] \quad (135)$$

where all modes associated with $G(\zeta)$ are unobservable.

It follows that both stabilising conjugators $G_r(\zeta) \in \mathcal{RH}_\infty^{(p+r) \times (p+r)}$ and $G_l(\zeta) \in \mathcal{RH}_\infty^{(m+q) \times (m+q)}$ being invertible do not create any new zero.

LEMMA 13 (on invariant zeros of stabilising J -lossless conjugators) *We have*

$$z(\hat{A}_r, BD_r, F_r, D_r) = z(\hat{A}_l, H_l, D_l C, D_l) = \lambda(A). \quad (136)$$

REMARK 7 For the existence of X_r and Y_l of *Theorem 1* it is required that matrix A of the corresponding pairs (A, B) and (A, C) has no eigenvalues on the $\partial\mathcal{D}_\Delta$. Let $\lambda \in \lambda(A)$ and $x \neq 0_n \in \mathbb{R}^n$ denote an associated eigenvector. Assume, contrary to the assertion, that $\lambda \in \partial\mathcal{D}_\Delta$. Since $\lambda(\hat{A}_r) \subset \mathcal{D}_\Delta$, it follows that $\lambda \notin \lambda(\hat{A}_r)$. From (130) we have $x \in \text{Ker } X_r$ and consequently $\hat{A}_r x = Ax = \lambda x$, which contradicts the stability of \hat{A}_r (see *Remark 3*).

Since $\text{Ker } X_r$ is A -invariant, we conclude that if $\lambda(A) \subset \mathbb{C} \setminus \bar{\mathcal{D}}_\Delta$ (i.e. if A has only strictly unstable eigenvalues) then the corresponding solution X_r is non-singular, $X_r > 0$. Let $\lambda(A) \subset \mathbb{C} \setminus \bar{\mathcal{D}}_\Delta$. If there exists a stabilising right J_{pr} -lossless conjugator associated with a controllable pair (A, B) , then the suitable solution X_r satisfies

$$X_r A + I_A A^T X_r - X_r B J_{pr} B^T I_A X_r = 0_{n \times n} \quad (137)$$

(see *Lemma 3*). Taking $Y_r = X_r^{-1}$, we conclude that the considered stabilising conjugator exists if and only if the following dual Lyapunov equation

$$A Y_r + Y_r A^T + \Delta A Y_r A^T - B J_{pr} B^T = 0_{n \times n} \quad (138)$$

has a solution $Y_r > 0$. Analogous arguments apply to the case of stabilising left dual J_{mq} -lossless conjugators with a $Y_l > 0$.

Consider similar pairs (A, B) and $(T^{-1}AT, T^{-1}B)$ with a non-singular $T \in \mathbb{R}^{n \times n}$. Let X_r and \hat{A}_r describe a stabilising right J_{pr} -lossless conjugator associated with (A, B) . It follows that $T^T X_r T$ and $T^{-1} \hat{A}_r T$ are the suitable matrices associated with $(T^{-1}AT, T^{-1}B)$. The same conclusion can be drawn for the case of stabilising left dual J_{mq} -lossless conjugators.

Finally, we can relax the controllability and the observability assumptions of *Theorem 1* by considering any stabilisable pair (A, B) and any detectable pair (A, C) , respectively, together with standard similarity transformations to suitable canonical state-space representations (Zhou et al., 1996).

5.4. Numerical conditioning of stabilising J -lossless conjugators

Let (U, W) be as described in *Theorem 1*. Setting $\bar{n} = p + r$ or $\bar{n} = m + q$ in accordance with the relevant type of conjugator, we have properly dimensioned matrices: $P \in \mathbb{R}^{n \times n}$, $Q \in \mathbb{R}^{n \times \bar{n}}$, $R = 0_{n \times n}$, $S = 0_{n \times \bar{n}}$ and $T \in \mathbb{R}^{\bar{n} \times \bar{n}}$. For a non-zero solution $\mathbb{R}^{n \times n} \ni X = \delta Ric(U, W)$ we define the following indices (see *Lemma 3.I*):

$$\kappa(U, W | X) = \frac{\| \begin{bmatrix} F_P & F_Q \end{bmatrix} \|_2}{\|X\|_F} \quad (139)$$

$$\bar{\kappa}(U, W | X) = \frac{\| \begin{bmatrix} \hat{F}_P & \Delta F_Q \end{bmatrix} \|_2}{\| \begin{bmatrix} F_P & F_Q \end{bmatrix} \|_2} \quad (140)$$

where

$$F_P = \|P\|_F H_c^{-1} H_P \quad (141)$$

$$\hat{F}_P = \|I_n + \Delta P\|_F H_c^{-1} H_P \quad (142)$$

$$F_Q = \|Q\|_F H_c^{-1} H_Q \quad (143)$$

$$H_P = -I_n \otimes (I_n + \Delta G_c^T) X - ((I_n + \Delta G_c^T) X \otimes I_n) T_{n,n} \quad (144)$$

$$H_Q = -F_c^T \otimes (I_n + \Delta G_c^T) X - ((I_n + \Delta G_c^T) X \otimes F_c^T) T_{n,\bar{n}} \quad (145)$$

$$F_c = -\bar{J}^{-1} Q^T X (I_n + \Delta P) \quad (146)$$

$$G_c = P + Q F_c \quad (147)$$

$$H_c = G_c^T \otimes I_n + I_n \otimes G_c^T + \Delta G_c^T \otimes G_c^T \quad (148)$$

$$\bar{J} = T + \Delta Q^T X Q \quad (149)$$

while

$$T_{n,m} = \sum_{i=1}^n \sum_{j=1}^m e_{n,i} e_{m,j}^T \otimes e_{m,j} e_{n,i}^T \quad (150)$$

denotes a vec-permutation matrix for $e_{k,l}$ as the l th unit vector in \mathbb{R}^k , while \otimes is the Kronecker matrix product, and $\|\cdot\|_2$ is the spectral matrix norm. Hence we have $(F_c, G_c) = (F_r, \hat{A}_r)$ or $(F_c, G_c) = (H_l^T, \hat{A}_l^T)$, respectively.

Consider two other indices suitably matched to the sensitivity analysis of the gain matrices (111) and (119) of stabilising J -lossless conjugators:

$$\kappa_g(U, W | X) = \frac{\| [M_P \quad M_Q] \|_2}{\| X(I_n + \Delta P)^{-1} Q^T \|_F} \quad (151)$$

$$\bar{\kappa}_g(U, W | X) = \frac{\| [\hat{M}_P \quad \Delta M_Q] \|_2}{\| [M_P \quad M_Q] \|_2} \quad (152)$$

where

$$M_P = \|P\|_F (L_{PQ} H_c^{-1} H_P + \Delta L_P) \quad (153)$$

$$\hat{M}_P = \|I_n + \Delta P\|_F (L_{PQ} H_c^{-1} H_P + \Delta L_P) \quad (154)$$

$$M_Q = \|Q\|_F (L_{PQ} H_c^{-1} H_Q + L_Q) \quad (155)$$

$$L_P = T Q^T (I_n + \Delta P^T)^{-1} \otimes X (I_n + \Delta P)^{-1} \quad (156)$$

$$L_Q = -T \otimes X (I_n + \Delta P)^{-1} \quad (157)$$

$$L_{PQ} = -T Q^T (I_n + \Delta P^T)^{-1} \otimes I_n. \quad (158)$$

Moreover, we will use the following three indices defined for $D \in \mathbb{R}^{\bar{n} \times \bar{n}}$:

$$\kappa_D(Q, X, T | D) = \frac{\| [G_Q \quad G_X] \|_2}{\| E_D^+ \text{vec}(D) \|} \quad (159)$$

$$\kappa_D(U, W | D, X) = \frac{\| [N_P \quad N_Q] \|_2}{\| E_D^+ \text{vec}(D) \|} \quad (160)$$

$$\bar{\kappa}_D(U, W | D, X) = \frac{\| [\hat{N}_P \quad \Delta N_Q] \|_2}{\| [N_P \quad N_Q] \|_2} \quad (161)$$

where

$$G_Q = \|Q\|_F U_D K_Q \quad (162)$$

$$G_X = \|E^+ \text{vec}(X)\| U_D K_X E \quad (163)$$

$$K_Q = -D^T \otimes D^T Q^T X - (D^T Q^T X \otimes D^T) T_{\bar{n}, \bar{n}} \quad (164)$$

$$K_X = -D^T Q^T \otimes D^T Q^T \quad (165)$$

$$U_D = (H_D E_D)^+ \quad (166)$$

$$H_D = I_{\bar{n}} \otimes D^T \bar{J} + (D^T \bar{J} \otimes I_{\bar{n}}) T_{\bar{n}, \bar{n}} \quad (167)$$

$$N_P = U_D K_X F_P \quad (168)$$

$$\hat{N}_P = U_D K_X \hat{F}_P \quad (169)$$

$$N_Q = U_D K_X F_Q + G_Q \quad (170)$$

and $E \in \mathbb{R}^{n^2 \times n(n+1)/2}$ of full column rank is a pattern matrix introduced in order to preserve the required symmetry of perturbed solutions to the relevant $\delta AREs$,

while $E_D \in \mathbb{R}^{\bar{n}^2 \times \bar{n}(\bar{n}+1)/2}$ of full column rank is a pattern matrix depending on the assumed particular structure of D_r and D_l .

Having obtained $X_r = \delta Ric(U_x, W_x)$ and $Y_l = \delta Ric(U_y, W_y)$ we can evaluate the properly defined relative condition numbers $\kappa_{X_r}(A, B)$ and $\kappa_{Y_l}(A, C)$, which describe the sensitivity of these (non-zero) solutions to perturbation in the distinguished input data matrices (see Section 3.4). At this moment we can also evaluate two analogously defined relative condition numbers $\kappa_{F_r}(A, B)$ and $\kappa_{H_l}(A, C)$ as convenient measures of the sensitivity of the conjugators gains F_r and H_l , respectively.

Next, we should compute $D_r(B, X_r)$ and $D_l(C, Y_l)$ satisfying (114) and (122), respectively. On account of Suchomski (2003b), we can easily obtain two suitable relative condition numbers $\kappa_{D_r}(B, X_r)$ and $\kappa_{D_l}(C, Y_l)$ characterising the sensitivity of these matrices with respects to perturbations in (B, X_r) and (C, Y_l) , respectively. Finally, let $\kappa_{D_r}(A, B)$ and $\kappa_{D_l}(A, C)$ denote suitably defined relative condition numbers of $D_r(A, B) = D_r(B, X_r(A, B))$ and $D_l(A, C) = D_l(C, Y_l(A, C))$, respectively. These indices refer directly to the relevant input data matrices.

LEMMA 14 (on conditioning of stabilising J -lossless conjugators) *Let $(A, B) \in \mathbb{R}^{n \times n} \times \mathbb{R}^{n \times (p+r)}$ and $(A, C) \in \mathbb{R}^{n \times n} \times \mathbb{R}^{(m+q) \times n}$. For a sufficiently small sampling period Δ it holds:*

(i) *a stabilising J -lossless conjugator associated with (A, B) or (A, C) is partially conditioned by:*

$$\kappa_{X_r}(A, B) = \kappa(U_x, W_x | X_r) \quad (171)$$

$$\frac{\kappa_{X_r q}(A_q, B_q)}{\kappa_{X_r}(A, B)} = \frac{1}{\Delta} \cdot \bar{\kappa}(U_x, W_x | X_r) \quad (172)$$

$$\kappa_{Y_l}(A, C) = \kappa(U_y, W_y | Y_l) \quad (173)$$

$$\frac{\kappa_{Y_l q}(A_q, C_q)}{\kappa_{Y_l}(A, C)} = \frac{1}{\Delta} \cdot \bar{\kappa}(U_y, W_y | Y_l); \quad (174)$$

(ii) *a stabilising J -lossless conjugator associated with (A, B) or (A, C) is partially conditioned by:*

$$\kappa_{F_r}(A, B) = \kappa_g(U_x, W_x | X_r) \quad (175)$$

$$\frac{\kappa_{F_r q}(A_q, B_q)}{\kappa_{F_r}(A, B)} = \frac{1}{\Delta} \cdot \bar{\kappa}_g(U_x, W_x | X_r) \quad (176)$$

$$\kappa_{D_r}(B, X_r) = \kappa_{D_r q}(B_q, X_{r q}) = \Delta \cdot \kappa_D(B, X_r, J_{pr} | D_r) \quad (177)$$

$$\kappa_{D_r}(A, B) = \Delta \cdot \kappa_D(U_x, W_x | D_r, X_r) \quad (178)$$

$$\frac{\kappa_{D_r q}(A_q, B_q)}{\kappa_{D_r}(A, B)} = \frac{1}{\Delta} \cdot \bar{\kappa}_D(U_x, W_x | D_r, X_r) \quad (179)$$

$$\kappa_{H_l}(A, C) = \kappa_g(U_y, W_y | Y_l) \quad (180)$$

$$\frac{\kappa_{H_l q}(A_q, C_q)}{\kappa_{H_l}(A, C)} = \frac{1}{\Delta} \cdot \bar{\kappa}_g(U_y, W_y | Y_l) \quad (181)$$

$$\kappa_{D_l}(C, Y_l) = \kappa_{D_l q}(C_q, Y_{lq}) = \Delta \cdot \kappa_D(C^T, Y_l, -J_{mq} | D_l) \quad (182)$$

$$\kappa_{D_l}(A, C) = \Delta \cdot \kappa_D(U_y, W_y | D_l, Y_l) \quad (183)$$

$$\frac{\kappa_{D_l q}(A_q, C_q)}{\kappa_{D_l}(A, C)} = \frac{1}{\Delta} \cdot \bar{\kappa}_D(U_y, W_y | D_l, Y_l). \quad (184)$$

REMARK 8 Matrix H_c is non-singular if and only if $\lambda_i + \lambda_j + \Delta\lambda_i\lambda_j \neq 0$, $\forall \lambda_i, \lambda_j \in \lambda(G_c)$. Since $X = \delta\text{Ric}(U, W)$ is assumed to be a stabilising solution to the relevant δARE of (20), we have $\lambda(G_c) \subset \mathcal{D}_\Delta$, and hence H_c is non-singular. Due to the fact that D_r and D_l are both non-unique the corresponding matrices H_D of (167) are singular.

Surveys of the Kronecker product, the vec operators, and vec-permutation matrices can be found in Henderson and Searle (1981), Higham (1996).

CONCLUSION 2 It is seen that using models defined in the δ -domain improves the conditioning of the problem of computing the gains of the stabilising J -lossless conjugators.

From (177) and (182) it follows that treating perturbations in X and Y as autonomous sources of the corresponding perturbations in D_r and D_l we observe that the assumed measures of sensitivity of these matrices, for both δ - and q -domain models, vanish to zero as $\Delta \rightarrow 0$, which can be referred to a 'continuous-time nature' of solutions to (114) and (122) as suitable constant J_{pr} -unitary and dual J_{mq} -unitary matrices, respectively. The situation changes significantly while we consider the overall influence of two elements of the corresponding pair (A, B) and (A, C) , respectively. Now, solutions we have for the δ -domain models are better conditioned than their q -domain counterparts.

Proceeding analogously, we can evaluate the suitable measures of sensitivity of solutions corresponding to the reduced-order pencil methodology (see *lemma 3.II*) applied to the relevant δARE s. We thus have

$$\kappa_R(U, W | X) = \frac{\| [F_P \quad F_R] \|_2}{\| X \|_F} \quad (185)$$

$$\bar{\kappa}_R(U, W | X) = \frac{\| [\hat{F}_P \quad \Delta F_R] \|_2}{\| [F_P \quad F_R] \|_2} \quad (186)$$

where

$$F_R = \| E^+ \text{vec}(R) \| H_c^{-1} H_R E \quad (187)$$

$$H_R = F_c^T \otimes F_c^T \quad (188)$$

$$F_c = -(I_n + \Delta X R)^{-1} X (I_n + \Delta P) \quad (189)$$

$$G_c = P + R F_c. \quad (190)$$

It is seen that all corresponding measures of conditioning are exactly the same for both approaches provided that the 'structure' of $R_x = BJ_{pr}B^T$ and $R_y = -C^T J_{mq}C$ is carefully taken into account. For example, taking $\kappa_R(U_x, W_x | X_r)$ instead of $\kappa_{X_r}(A, B) = \kappa(U_x, W_x | X_r)$ usually yields overestimated measures of sensitivity of $X_r(A, B)$.

6. Numerical example

Conditioning of synthesis of stabilising right J_{pr} -lossless conjugators associated with a given generalised plant will be examined. Let us start with the following n th-order continuous-time system (Linnemann and Kawelke, 1999)

$$G_n^{(\alpha, \beta)}(s) = \left[\begin{array}{c|c} A_n^{(\alpha, \beta)} & b_n \\ \hline c_n^T & 0 \end{array} \right] = \left[\begin{array}{cccc|c} -\alpha & \beta & & & 1 \\ -1/\beta & -\alpha & \beta & & 0 \\ & -1/\beta & -\alpha & \ddots & \vdots \\ & & \ddots & \ddots & \vdots \\ 0 & & & -1/\beta & \beta \\ \hline 1 & 0 & \dots & \dots & 0 \end{array} \right]. \quad (191)$$

The transfer function $G_n^{(\alpha, \beta)}(s)$ is independent of β . However, the sensitivity of $|G_n^{(\alpha, \beta)}(j\omega)|$ does strongly depend on β . This observation makes $G_n^{(\alpha, \beta)}(s)$ a good candidate for being 'a prototype' function for our sensitivity studies. The parameter α mainly influences the stability of the system and the 'rate of change' in $|G_n^{(\alpha, \beta)}(j\omega)|$.

The considered generalised plant (process) is given in Fig. 2, where it is assumed that $G_1(s) = G_n^{(\alpha_1, \beta_1)}(s)$ and $G_2(s) = G_n^{(\alpha_2, \beta_2)}(s)$.

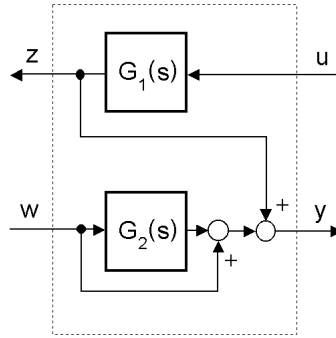

Figure 2. Generalised plant.

It results in the following continuous-time scattering matrix

$$P(s) = \left[\begin{array}{cc|cc} A_n^{(\alpha_1, \beta_1)} & 0_{n \times n} & 0_n & b_n \\ 0_{n \times n} & A_n^{(\alpha_2, \beta_2)} & b_n & 0_n \\ \hline c_n^T & 0_{1 \times n} & 0 & 0 \\ c_n^T & c_n^T & 1 & 0 \end{array} \right] \quad (192)$$

and the corresponding chain-scattering representation

$$G(s) = \left[\begin{array}{cc|cc} A_n^{(\alpha_1, \beta_1)} & 0_{n \times n} & b_n & 0_n \\ -b_n c_n^T & A_n^{(\alpha_2, \beta_2)} - b_n c_n^T & 0_n & b_n \\ \hline c_n^T & 0_{1 \times n} & 0 & 0 \\ -c_n^T & -c_n^T & 0 & 1 \end{array} \right]. \quad (193)$$

Let $G_1(s) = G_7^{(0.1, 2)}(s)$ and $G_2(s) = G_7^{(-0.5, 6)}(s)$. Pole-zero maps of the corresponding $P(s)$ and $G(s)$ are presented in Figs. 3a and 3b, respectively.

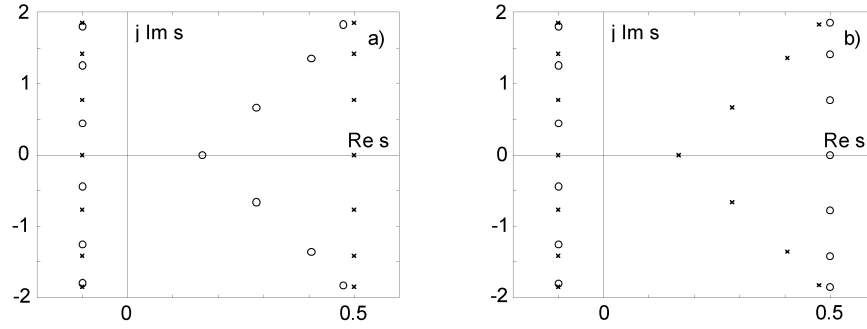

Figure 3. Pole-zero maps for systems described by: a) scattering matrix, b) chain-scattering matrix.

Conditioning of the relevant discrete-time Riccati equations and the tasks of computing the conjugator gains being parameterised by matrices A and B of the suitable chain-scattering models is illustrated in Figs. 4a and 4b. Plots given in Figs. 4c and 4d refer to conditioning of computing the considered matrices D_r . As it can be observed, problems we are dealing with are relatively ill conditioned.

Let $\varepsilon_x = \|x - \tilde{x}\|/\|x\|$ denote the relative error of a particular solution to the δARE of (20) parameterised as it is shown in (107) and the relative error of a particular solution to the simplified ARE of (114), both obtained for a perturbed model of the plant: x is the exact solution while \tilde{x} represents a perturbed solution corresponding to the suitable pair (A, B) expressed in the single

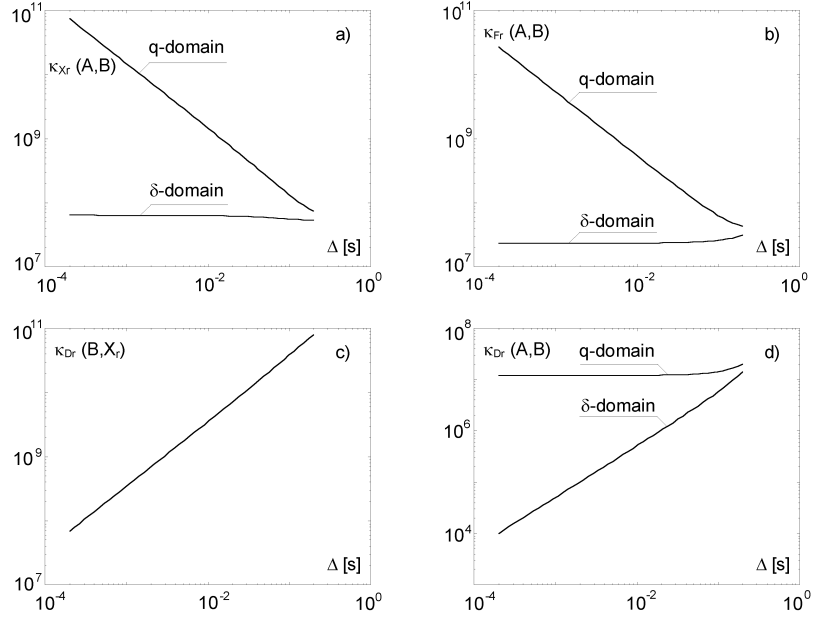

Figure 4. Conditioning of synthesis of stabilising right J_{pr} -lossless conjugators: a) conditioning of X , b) conditioning of F_r , c,d) conditioning of D_r .

precision of the IEEE floating point arithmetic (Higham, 1996; Overton, 2001; Williamson, 1991). Moreover, we assume that $D_r \in \mathbb{R}^{2 \times 2}$ of the common symmetric structure ($D_r = D_r^T$) is treated as a 'generic' solution to (114). Results of computations performed for $x \equiv X$, $x \equiv F_r$ and $x \equiv D_r$ are presented in Figs. 5a, 5b and 5c, respectively. The frequency-domain error $e_G = \|G_r - \tilde{G}_r\|_\infty$ is illustrated in Fig. 6, where \tilde{G}_r denotes the resulting perturbed stabilising right J_{pr} -lossless conjugator.

On account of the above results it can thus be concluded that the δ -domain approach turns out to be clearly superior to the conventional shift formulation when the numerical conditioning of the relevant equations is the subject of interest. In particular, starting from a simple observation that for a given sampling period Δ the gain matrices of both considered discrete-times conjugators are equal (i.e. $F_r = F_{rq}$), we can claim that if Δ is sufficiently small, obtaining of these gains is numerically more tractable if we use the δ -domain models.

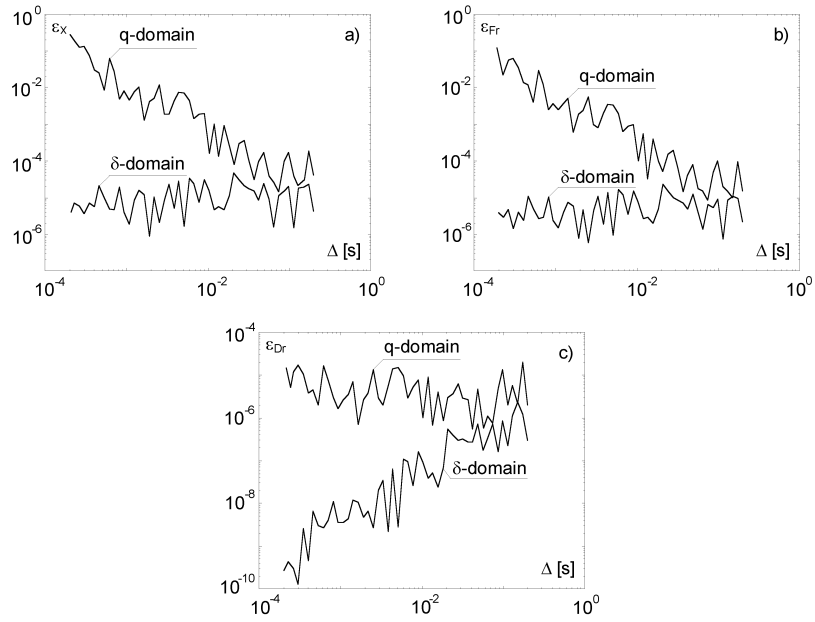
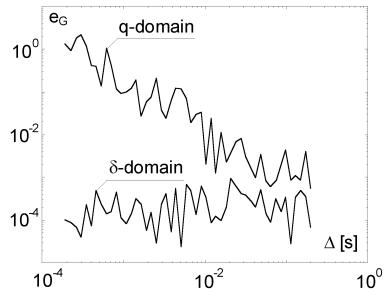

 Figure 5. Relative errors of solutions: a) X , b) F_r , c) D_r .

Figure 6. Frequency-domain errors.

It can easily be seen that a set of solutions to (114) can be represented as $\{D_r \bar{J}(\nu), \nu \in \mathbb{R}\}$, where $\bar{J}(\nu) \in \mathbb{R}^{2 \times 2}$ denotes the following one parameter J_{11} -unitary matrix

$$\bar{J}(\nu) = \begin{bmatrix} \sqrt{1+\nu^2} & \nu \\ -\nu & -\sqrt{1+\nu^2} \end{bmatrix}, \quad \nu \in \mathbb{R}. \quad (194)$$

Taking $\Delta = 0.05$ [s] yields

$$D_r = \begin{bmatrix} 1.00003495 & -0.02302945 \\ -0.02302945 & -0.88193572 \end{bmatrix}. \quad (195)$$

The relevant upper triangular solution described in *Lemma 12* can thus be represented as

$$\begin{bmatrix} 1.00097763 & 0.04915952 \\ 0 & 0.88163499 \end{bmatrix} = D_r \bar{J}(0.02612130). \quad (196)$$

The suitable pattern matrices E_D matched to the celebrated symmetric solution and the upper triangular solution are

$$\begin{bmatrix} 1 & 0 & 0 \\ 0 & 1 & 0 \\ 0 & 1 & 0 \\ 0 & 0 & 1 \end{bmatrix} \quad \text{and} \quad \begin{bmatrix} 1 & 0 & 0 \\ 0 & 0 & 0 \\ 0 & 1 & 0 \\ 0 & 0 & 1 \end{bmatrix}, \quad \text{respectively.}$$

Finally, plots given in Fig. 7 show how the assumed structure of D_r affects the conditioning of equation (114). It is seen that the upper triangular solutions are a bit worse conditioned. This confirms a frequently observed phenomenon that solutions having more complicated (restricted) structures are usually more sensitive to input data perturbation.

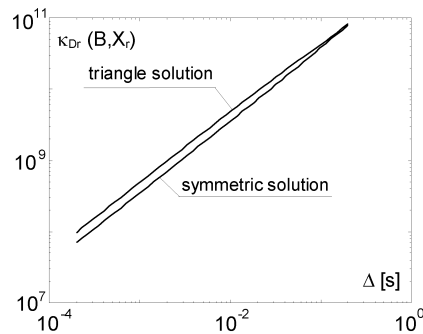

Figure 7. Influence of structure of D_r on partial conditioning of synthesis of stabilising right J_{pr} -lossless conjugators.

7. Conclusions

The J -losslessness property of real-rational functions and especially the J -lossless factorisations of such functions play the key role in robust control design methodologies based on the \mathcal{H}_∞ paradigms. Moreover, the suitable J -lossless

factorisations are closely related to the convenient cascade structure of closed-loop control systems, which are exploited in the common framework of the chain-scattering representation of the plant. Motivated by this, after having presented some background definitions, lemmas and properties concerning mainly the pole-zero properties of chain-scattering models as well as the δ -domain Riccati equations, we considered the problem of synthesis of stabilising J -lossless conjugators in the numerically stable manner by employing some δ -domain mechanisms.

The material presented in this paper establishes a suitable basis for the further work concerning the general problem of numerically reliable synthesis of the discrete-time \mathcal{H}_∞ optimal control. In the forthcoming second part of our work, some fundamental structural properties of the δ -operator \mathcal{H}_∞ sub-optimal controllers based on J -lossless approaches will be studied and convenient new conditions for the existence of strictly proper solutions will be given. It will also be confirmed that rationally designed algorithms embedded in \mathcal{H}_∞ and based on the δ -domain models are better conditioned as compared to their counterparts employing the conventional shift operator q .

References

- ABELS, J. and BENNER, P. (1999) CAREX (DAREX) - a collection of benchmark examples for continuous-time (discrete-time) Riccati equations. *SLICOT Working Note*, **14/16**, Katholieke Univ., Leuven, Belgium.
- ARNOLD, W.F. and LAUB, A.J. (1984) Generalized eigenproblem algorithms and software for algebraic Riccati equations. *Proc. IEEE* **72**(12), 1746–1754.
- ÅSTRÖM, K.J., HAGANDER, P. and STERNBY, J. (1984) Zeros of sampled systems. *Automatica*, **20**, (1), 31–38.
- BENNER, P., LAUB, A.J. and MEHRMANN, V. (1995) A collection of benchmark examples for the numerical solution of algebraic Riccati equations. I: continuous-time case, II: discrete-time case. *TU Chemnitz-Zwickau Techn. Report*, **95-22/95-23**, Fakultät für Mathematik, TU Chemnitz-Zwickau, Germany.
- BENNER, P., LAUB, A.J. and MEHRMANN, V. (1997) Benchmarks for the numerical solution of algebraic Riccati equations. *IEEE Control Systems Mag.* **17**(5), 18–28.
- BOGNAR, J. (1974) *Indefinite Inner Product Spaces*. Springer Verlag, Berlin, Heidelberg.
- BUNSE-GERSTNER, A., BYERS, R. and MEHRMANN, V. (1992) A chart of numerical methods for structured eigenvalue problems. *SIAM Journ. Matrix Anal. Appl.* **13**(2), 419–453.
- CHENG, H.W. and YAU, S.S.T. (1997) More explicit formulas for the matrix exponential. *Linear Algebra Appl.* **262**, 131–163.

- CHRISTOV, N.D., KONSTANTINOV, M.M. and PETKOV, P.H. (2005) Improved perturbation bounds for the continuous-time \mathcal{H}_∞ -optimization problem. *Proc. 16th IFAC World Congress*, Prague, Czech Republic, CD-ROM.
- COLLINS JR, E.G., HADDAD, W.M. and CHALLEBOINA, V. (1997) Robustness analysis in the delta-domain using fixed-structure multipliers. *Proc. 36th Conf. Decision and Control*, San Diego, CA, 3286–3291.
- COLLINS JR, E.G. and SONG, T. (1999) A delta operator approach to discrete-time \mathcal{H}_∞ control. *Int. Journ. Control* **72**(4), 315–320.
- CONWAY, J.B. (1978) *Functions of One Complex Variable*. Springer Verlag, New York, Heidelberg.
- DATTA, B.N. (2004) *Numerical Methods for Linear Control Systems*. Elsevier Academic Press, Amsterdam, Boston.
- DEVILDE, P. and DYM, H. (1981) Lossless chain-scattering matrices and optimum linear prediction: the vector case. *Circuit Theory Appl.* **9**(2), 135–175.
- DULLERUD, G.E. and PAGANINI, F. (2000) *A Course in Robust Control Theory*. Springer Verlag, New York, Berlin.
- FAN, H.H. (1997) A structural view of asymptotic convergence speed of adaptive IIR filtering algorithms - Part II: Finite precision implementation. *IEEE Trans. Signal Processing* **45**(6), 1458–1472.
- FAN, H.H. and LIU, X. (1994) Delta Levinson and Schur-type RLS algorithms for adaptive signal processing. *IEEE Trans. Signal Processing* **42**(7), 1629–1639.
- FEINTUCH, A. (1998) *Robust Control Theory in Hilbert Space*. Springer Verlag, New York, Berlin.
- FEUER, A. and MIDDLETON, R.H. (1995) Conditioning of LMS algorithms with fast sampling. *IEEE Trans. Automatic Control* **43**(8), 1978–1981.
- FRANCIS, B.A. (1987) *A Course in \mathcal{H}_∞ Control Theory*. Springer Verlag, Berlin, Heidelberg.
- FUHRMANN, P.A. (1996) *A Polynomial Approach to Linear Algebra*. Springer Verlag, New York, Berlin.
- GAHINET, P. and LAUB, A.J. (1997) Numerically reliable computation of optimal performance in singular \mathcal{H}_∞ control. *SIAM Journ. Control Optim.* **35**(5), 1690–1710.
- GENIN, Y., VAN DOOREN, P., KAILATH, T., DELOSME, J. and MORF, M. (1983) On Σ -lossless transfer functions and related questions. *Linear Algebra Appl.* **50**, 251–275.
- GESSING, R. (1993) About some properties of discrete-time transfer functions for small sampling periods. *Proc. 2nd European Control Conf.*, Groningen, The Netherlands **3**, 1699–1702.
- GESSING, R. (2002) Whether the delta operator models are really better for small sampling periods. *Proc. 15th IFAC World Congress*, Barcelona, Spain, T-We-M21 (CD-ROM).

- GOODWIN, G.C., MIDDLETON, R.H. and POOR, H.V. (1992) High-speed digital signal processing and control. *Proc. IEEE* **80**(2), 240–259.
- GREEN, M. (1992) \mathcal{H}_∞ controller synthesis by J -lossless coprime factorisation. *SIAM Journ. Control Optim.* **30**(3), 522–547.
- GREEN, M., GLOVER, K., LIMEBEER, D.J.N. and DOYLE, J.C. (1990) A spectral factorization approach to \mathcal{H}_∞ control. *SIAM Journ. Control Optim.* **28**(6), 1350–1371.
- GREEN, M. and LIMEBEER, D.J.N. (1995) *Linear Robust Control*. Prentice Hall, Inc., Englewood Cliffs, N.J.
- HARA, S., IWASAKI, T. and SHIOKATA, D. (2006) Robust PID control using generalized KYP synthesis. *IEEE Control Systems Mag.* **26**(1), 80–91.
- HASSIBI, B., SAYED, A.H. and KAILATH, T. (1999) *Indefinite-Quadratic Estimation and Control. A Unified Approach to \mathcal{H}_2 and \mathcal{H}_∞ Theories*. SIAM, Philadelphia, PA.
- HENDERSON, H.V. and SEARLE, S.S. (1981) The vec-permutation matrix, the vec operator and Kronecker products: A review. *Linear and Multilinear Algebra* **9**, 271–288.
- HIGHAM, N.J. (1996) *Accuracy and Stability of Numerical Algorithms*. SIAM, Philadelphia, PA.
- HIGHAM, N.J., KONSTANTINOV, M., MEHRMANN, V. and PETKOV, P. (2004) The sensitivity of computational control problems. *IEEE Control Systems Mag.* **24**(1), 28–43.
- HUNG, Y.S. and CHU, D. (1998) (J, J') -lossless factorisation for discrete-time systems. *Int. Journ. Control* **71**(3), 517–533.
- IGLESIAS, P.A. and GLOVER, K. (1991) State-space approach to discrete-time \mathcal{H}_∞ control. *Int. Journ. Control* **54**(5), 1031–1073.
- IONESCU, V., OARĂ, C. and WEISS, M. (1997) General matrix pencil techniques for the solution of algebraic Riccati equations: a unified approach. *IEEE Trans. Automatic Control* **42**(8), 1085–1097.
- IONESCU, V., OARĂ, C. and WEISS, M. (1999) *Generalised Riccati Theory and Robust Control*. John Wiley and Sons, Chichester, New York.
- IONESCU, V. and WEISS, M. (1992) On computing the stabilizing solution of the discrete-time Riccati equation. *Linear Algebra Appl.* **174**, 229–238.
- IONESCU, V. and WEISS, M. (1993) Two-Riccati formulae for the discrete-time \mathcal{H}_∞ control problem. *Int. Journ. Control* **57**(1), 141–195.
- JOHNSON, J.C. and PHILLIPS, C.L. (1971) An algorithm for the computation of the integral of the state transition matrix. *IEEE Trans. Automatic Control* **16**(2), 204–205.
- KAILATH, T. (1980) *Linear Systems*. Prentice Hall, Inc., Englewood Cliffs, N.J.
- KAILATH, T., SAYED, A.H. and HASSIBI, B. (2000) *Linear Estimation*. Prentice Hall, Inc., Upper Saddle River, N.J.

- KENNEY, C., LAUB, A.J. and WETTE, M. (1989) A stability-enhancing scaling procedure for Schur-Riccati solvers. *Systems Control Letters* **12**(2), 241–250.
- KIMURA, H. (1989) Conjugation, interpolation and model matching in \mathcal{H}_∞ . *Int. Journ. Control* **49** (1), 269–307.
- KIMURA, H. (1991) Generalized chain-scattering approach to \mathcal{H}_∞ control problems. In: S.P. Bhattcharyya, L.H. Keel, eds., *Control of Uncertain Dynamic Systems*. CRC Press, Boca Raton, FL, 21–38.
- KIMURA, H. (1992a) (J, J') -lossless factorisation using conjugations of zero and pole extractions. In: S. Hosoe, ed., *Robust Control*. Springer Verlag, Berlin, Heidelberg, 1–8.
- KIMURA, H. (1992b) (J, J') -lossless factorization based on conjugation. *Systems Control Letters* **19**(1), 95–109.
- KIMURA, H. (1995) Chain-scattering representation, J -lossless factorization and \mathcal{H}_∞ control. *Journ. Math. Systems Estimation Control* **5**(2), 203–255.
- KIMURA, H. (1997) *Chain-Scattering Approach to \mathcal{H}_∞ Control*. Birkhäuser, Boston, Basel.
- KIMURA, H. and OKUNISHI, F. (1995) Chain-scattering approach to control system design. In: A. Isidori, ed., *Trends in control. A European perspective*. Springer Verlag, Berlin, Heidelberg, 151–171.
- KONGPRAWACHNON, W. and KIMURA, H. (1996) J -lossless conjugation and factorization for discrete-time systems. *Int. Journ. Control* **65**(5), 867–884.
- KONGPRAWACHNON, W. and KIMURA, H. (1998) J -lossless factorization and \mathcal{H}_∞ control for discrete-time systems. *Int. Journ. Control* **70**(3), 423–446.
- KONSTANTINOV, M., GU, D.W., MEHRMANN, V. and PETKOV, P. (2003) *Perturbation Theory for Matrix Equations*. Elsevier Science, North-Holland, Amsterdam, Boston.
- KONSTANTINOV, M., PETKOV, P.H. and CHRISTOV, N.D. (1995) Conditioning of the continuous-time \mathcal{H}_∞ optimisation problem. *Proc. 3rd European Control Conf.*, Rome, Italy, 613–618.
- LANCASTER, P. and RODMAN, L. (1995) *Algebraic Riccati Equations*. Clarendon Press, Oxford.
- LAUB, A.J. (1979) A Schur method for solving algebraic Riccati equations. *IEEE Trans. Automatic Control* **24**(6), 913–921.
- LAUB, A.J. (1991) Invariant subspace methods for the numerical solution of Riccati equations. In: S. Bittani, A.J. Laub and J.C. Willems, eds., *The Riccati Equation*. Springer Verlag, Berlin, Heidelberg, 163–196.
- LEE, P.H., KIMURA, H. and SOH, Y.C. (1996) On the lossless and J -lossless embedding theorems in \mathcal{H}_∞ . *Systems and Control Letters* **29**(1), 1–7.

- LI, Q. and FAN, H.H. (1996) On properties of information matrices of delta-operator based adaptive signal processing algorithms. *IEEE Trans. Signal Processing* **45**(10), 2454–2467.
- LIN, W.W., WANG, C.S. and XU, Q.F. (2000) Numerical computation of the minimal \mathcal{H}_∞ norm of the discrete-time output feedback control problem. *SIAM Journ. Numerical Analysis* **38**(2), 515–547.
- LINNEMANN, A. and KAWELKE, J. (1999) \mathcal{H}_∞ -norm and frequency-response computations – sensitivity and a reliable algorithm. *IMA Journ. Mathematical Control and Information* **16**, 249–259.
- LIU, K.Z. and MITA, T. (1989) Conjugation and \mathcal{H}_∞ control of discrete-time systems. *Int. Journ. Control* **50**(4), 1435–1460.
- MEYER, C.D. (2000) *Matrix Analysis and Applied Linear Algebra*. SIAM, Philadelphia, PA.
- MIDDLETON, R.H. and GOODWIN, G.C. (1986) Improved finite word length characteristics in digital control using delta operators. *IEEE Trans. Automatic Control* **31**(11), 1015–1021.
- MIDDLETON, R.H. and GOODWIN, G.C. (1990) *Digital Control and Estimation*. Prentice Hall: Englewood Cliffs, N.J.
- MOLER, C. and VAN LOAN, C.F. (1978) Nineteen dubious ways to compute the exponential of a matrix. *SIAM Review* **20**(4), 801–836.
- NEUMAN, C.P. (1993a) Transformations between delta and forward shift operator transfer function models. *IEEE Trans. Systems, Man, and Cybernetics* **23**(1), 295–296.
- NEUMAN, C.P. (1993b) Properties of the delta operator model of dynamic physical systems. *IEEE Trans. Systems, Man, and Cybernetics* **23**(1), 296–301.
- NINNESS, B.M. and GOODWIN, G.C. (1991) The relationship between discrete time and continuous time linear estimation. In: N.K. Sinha and G.P. Rao, eds., *Identification of Continuous-Time Systems*. Kluwer Academic Publishers, Dordrecht, 79–122
- OVERTON, M.L. (2001) *Numerical Computing with IEEE Floating Point Arithmetic*. SIAM, Philadelphia, PA.
- PAPPAS, T., LAUB, A.J. and SANDELL, N.R. (1980) On the numerical solution of the discrete-time algebraic Riccati equations. *IEEE Trans. Automatic Control* **25**(4), 631–641.
- PETKOV, P.H., CHRISTOV, N.D. and KONSTANTINOV, M.M. (1987) On the numerical properties of the Schur approach for solving the matrix Riccati equation. *Systems and Control Letters* **9**(2), 197–201.
- PETKOV, P.M., KONSTANTINOV, M.M. and MEHRMANN, V. (1998) DGRSVX and DMSRIC: Fortran 77 subroutines for solving continuous-time matrix algebraic Riccati equations with condition and accuracy estimates. *TU Chemnitz-Zwickau Techn. Report, SFB393/98-16*, Fakultät für Mathematik, TU Chemnitz-Zwickau, Germany.

- PREMARATNE, K., SALVI, R., HABIB, N.R. and LE GALL, J.P. (1994) Delta-operator formulated discrete-time approximations of continuous-time systems. *IEEE Trans. Automatic Control* **39**(3), 581–585.
- RAO, G.P. and SINHA, N.K. (1991) Continuous-time models and approaches. In: N.K. Sinha and G.P. Rao, eds., *Identification of Continuous-Time Systems*. Kluwer Academic Publishers, Dordrecht, 1–15.
- ROSTGAARD, M., POULSEN, N.K. and RAVN, O. (1993) A rapprochement between discrete-time operators. *Proc. 2nd European Control Conf.*, Groningen, The Netherlands, 426–431.
- SABERI, A., SANNUTI, P. and CHEN, B.M. (1995) *\mathcal{H}_2 Optimal Control*. Prentice-Hall, Inc., Englewood Cliffs, N.J.
- SALGADO, M., MIDDLETON, R. and GOODWIN, G.C. (1988) Connection between continuous and discrete Riccati equations with applications to Kalman filtering *IEE Proc., Control Theory and Appl.* **135**(1), 28–34.
- SKOGESTAD, S. and POSTLETHWAITE, I. (1996) *Multivariable Feedback Control*. John Wiley and Sons Ltd, Chichester, New York.
- STOORVOGEL, A. (1992a) *The \mathcal{H}_∞ Control Problem. A State Space Approach*. Prentice Hall, Inc., New York.
- STOORVOGEL, A. (1992b) The discrete time \mathcal{H}_∞ control problem with measurement feedback. *SIAM Journ. Control Optim.* **30**(1), 182–202.
- STOORVOGEL, A. and SABERI, A. (1998) The discrete algebraic Riccati equation and linear matrix inequality. *Linear Algebra Appl.* **274**(3), 317–365.
- SUCHOMSKI, P. (1995) J -lossless coprime factorisation approach to weighted mixed sensitivity sub-optimal synthesis in \mathcal{H}_∞ . *Proc. 2nd Int. Symp. Methods and Models in Automation and Robotics MMAR'95*, Międzyzdroje, Poland **1**, 211–216.
- SUCHOMSKI, P. (2001a) Numerically robust delta-domain solutions to discrete-time Lyapunov equations. *Systems and Control Letters* **47**(4), 319–326.
- SUCHOMSKI, P. (2001b) Numerical conditioning of delta-domain Lyapunov and Riccati equations. *IEE Proc., Control Theory and Appl.* **148**(6), 497–501.
- SUCHOMSKI, P. (2001c) Robust design in delta domain for SISO plants: phase advance and phase lag controllers. *Systems Analysis Modelling Simulation* **41**(3), 503–549.
- SUCHOMSKI, P. (2002) A J -lossless factorization approach to \mathcal{H}_∞ control in delta domain. *Automatica* **38**(10), 1807–1814.
- SUCHOMSKI, P. (2003a) J -lossless and extended J -lossless factorizations approach for delta-domain \mathcal{H}_∞ control. *Int. Journ. Control* **76**(8), 794–809.
- SUCHOMSKI, P. (2003b) Remarks about numerical conditioning of discrete-time Riccati equations. *IEE Proc., Control Theory and Appl.* **150**(5), 449–456.
- SUCHOMSKI, P. (2003c) Numerically robust synthesis of discrete-time \mathcal{H}_∞ estimators based on J -lossless factorisations. *Control and Cybernetics* **32**(4), 761–802.

- SUCHOMSKI, P. (2003d) Robust pole placement in delta domain for SISO plants. *Systems Analysis Modelling Simulation* **43**(4), 483–512.
- SUCHOMSKI, P. (2003e) J -lossless factorisations for robust \mathcal{H}_∞ -control in delta-domain. *Systems Analysis Modelling Simulation* **43**(4), 525–555.
- SUCHOMSKI, P. (2004) *Synthesis of Discrete-Time Robust Control Algorithms*. Systems Research Institute, Polish Academy of Science, Warsaw, in Polish.
- TSAI, M.C. and POSTLETHWAITE, I. (1991) On J -lossless co-prime factorizations and \mathcal{H}_∞ control. *Int. Journ. Robust Nonlin. Control* **1**(1), 47–68.
- TSAI, M.C. (1995) J -lossless coprime factorisation approach to weighted mixed sensitivity sub-optimal synthesis in \mathcal{H}_∞ . *Proc. 2nd Int. Symp. Methods and Models in Automation and Robotics MMAR'95*, Międzyzdroje, Poland **1**, 211–216.
- TSAI, M.C. and TSAI, C.S. (1992) Formulation of the \mathcal{H}_∞ control problem by using chain-scattering matrix description. *Proc. American Control Conf.*, Chicago, 1870–1871.
- TSAI, M.C. and TSAI, C.S. (1993) A chain scattering-matrix description approach to \mathcal{H}_∞ control. *IEEE Trans. Automatic Control* **38**(9), 1416–1421.
- TSAI, M.C. and TSAI, C.S. I. (1995) A transfer matrix framework approach to the synthesis of \mathcal{H}_∞ controllers. *Int. Journ. Robust Nonlin. Control* **5**(2), 155–173.
- TSAI, M.C., TSAI, C.S. and SUN, Y.Y. (1993) On discrete-time \mathcal{H}_∞ control: A J -lossless coprime factorization approach. *IEEE Trans. Automatic Control* **38**(7), 1143–1147.
- VAN DOOREN, P.M. (1981) A generalized eigenvalue approach for solving Riccati equations. *SIAM Journ. Sci. Stat. Comput.* **2**(2), 121–135.
- VAN DOOREN, P.M. (2004) The basic developing numerical algorithms. *IEEE Control Systems Mag.* **24**(1), 18–27.
- VIDYASAGAR, M. (1985) *Control System Synthesis - A Factorisation Approach*. MIT Press, Cambridge, MA.
- WAHLBERG, B. (1988) Limit results for sampled systems. *Int. Journ. Control* **48**(3), 1267–1283.
- WAHLBERG, B. (1990) The effects of rapid sampling in system identification. *Automatica* **26**(1), 167–170.
- WARD, R.C. (1977) Numerical computation of the matrix exponential with accuracy estimate. *SIAM Journ. Numerical Analysis* **14**(3), 600–610.
- WILLIAMSON, D. (1991) *Digital Control and Implementation. Finite Word-length Considerations*. Prentice Hall, Englewood Cliffs, N.J.
- ZHOU, K., DOYLE, J.C. and GLOVER, K. (1996) *Robust and Optimal Control*. Prentice Hall, Upper Saddle River, NJ.

